

SPECTRUM

SPORTS INTL

ULTIMATE BUNGEE™ OWNER/OPERATOR'S MANUAL



Attention!

IMPORTANT SAFETY INFORMATION INSIDE. READ THIS MANUAL BEFORE SETTING UP AND OPERATING THE ULTIMATE BUNGEE™.

Product Identification: Ultimate Bungee™

Product Name: _____

Model: _____ Date Manufactured: _____

Specialty Items: _____

Serial Number: _____

Passenger Capacity: _____

Company Name: _____

Customer Name: _____

Phone Number: _____

Address: _____

Certification:

I have read and understand the Receipt & Acknowledgement, Release of Liability, and Agreement & Acknowledgement in this manual.

*Please mail or fax to:
3785 N. Hwy. 91
Hyde Park, UT 84318
Fax: (435) 792-3884

TABLE OF CONTENTS

Ultimate Bungee™ i

Owner/Operator’s Manual i

Product Identification: Ultimate Bungee™ ii

Table of Contentsiii-v

List of Tablesv-vi

List of Figuresv-vi

1. Introduction 1

1.1 Receipt & Acknowledgment2

1.2 Manual Overview3

 1.2.1 Revisions..... 3

 1.2.2 Warning Signs..... 3

1.3 Product Overview4

1.4 Accident Reporting4

1.5 Certifications / Standards.....5

 1.5.1 ASTM Requirements for Owner/Operator Responsibilities 5

 1.5.2 Engineering Approval 5

2. Product Setup 6

2.1 Identify a Safe Operating Area.....6

2.2 Remove the Trailer6

2.3 Stabilize the Trailer7

2.4 Remove the Fencing.....7

2.5 Reposition the Auto-Bungee® Cable8

2.6 Raise the Support Arms.....9

 2.6.1 Outside Arms (4 QTY)..... 10

 2.6.2 Center Arms (2 QTY)..... 11

2.7 Install the Aluminum Poles.....11

2.8 Attach the Ropes & Bungees13

2.9 Raise the Aluminum Poles.....15

2.10 Turn on the Master Power.....16

2.11 Attach the Banners17

2.12 Inflate the Jump Pods.....17

2.13 Trampoline Option.....17

2.14 Position the Fencing.....17

3. Inspections 18

3.1 Inspection Checklists.....19

3.1.1 Quick Reference Checklist.....	19
3.1.2 Daily Inspection Checklist.....	20
3.1.3 Monthly Inspection Checklist.....	22
3.1.4 Annual Inspection Checklist	23
3.2 Rope Inspections	24
3.2.1 Wire Rope Inspection Comparison	26
3.3 Cable Inspections	28
3.3.1 Replacing the Cable.....	28
3.3.2 Cable Replacement Options.....	29
3.4 Non-Destructive Examination (NDE) Inspection Policy.....	30
3.5 Ultimate Bungee™ Stickers.....	31
3.6 Auto-Bungee® Stickers.....	32
4. Operations.....	35
4.1 Rider Restrictions.....	35
4.2 Ride Cycle	36
4.3 Emergency Evacuation Plan.....	37
5. Take-Down	38
5.1 Dismantle the Inflatable Jump Pods.....	38
5.2 Remove the Banners	38
5.3 Dismantle the Fencing.....	38
5.4 Lower the Poles	38
5.5 Remove the Ropes & Bungees	39
5.6 Moving the Poles to the Storage Rack.....	40
5.7 Lower the Support Arms	41
5.7.1 Lowering the Outside Arms.....	41
5.7.2 Lowering the Center Arms	42
5.8 Repositioning the Auto-Bungee® Cables.....	43
5.9 Rack the Fencing.....	43
6. Transportation.....	44
6.1 Pre-Trip Inspection.....	44
6.2 Connect to the Tow Vehicle.....	44
6.2 Transporting the Climbing Tower	45
7. Maintenance	46
7.1 Maintenance Schedule.....	46
7.1.1 Monthly Maintenance Schedule	46
7.1.2 Annual Maintenance Schedule	46
7.1.3 Maintaining Wear Items	46
7.2 Service Options.....	47
7.3 Cleaning	48
7.4 Product Storage (Winterization)	48
8. Warranty	49
Appendices	54
Appendix A. Forms	55

Appendix B. Accident Reporting 56
Appendix C. Wiring..... 58

LIST OF TABLES

Table 1. Warning Signs.....3
 Table 2. Quick-Reference Checklist..... 19
 Table 3. Daily Inspections Checklist 20
 Table 4. Monthly Inspections Checklist..... 22
 Table 5. Annual Inspections Checklist 23
 Table 6. Wire Rope Inspection Comparison 26
 Table 7. Allowable broken strands by ASME Code 27
 Table 8. Jumper Weight and the Associated Bands per Side 36

LIST OF FIGURES

Figure 1. Trailer Crank Handle7
 Figure 2. Repositioning the Auto-Bungee® Cable8
 Figure 3. Releasing the Support Arms9
 Figure 4. Removing the U-Clip..... 10
 Figure 5. Lining up the Brace Rod..... 10
 Figure 6. Fully Extended Support Arm 11
 Figure 7. Aluminum Poles on Rack..... 11
 Figure 8. Matching the Aluminum Poles to the Mount..... 12
 Figure 9. Beveled Edge of the Aluminum Pole..... 12
 Figure 10. Attached Rope Pulley 13
 Figure 11. Attached Inside Rope Pulley 13
 Figure 12. Checking the Pulleys..... 14
 Figure 13. Hydraulic Lift Switch..... 15
 Figure 14. Locking the Poles into the Support Arms 15
 Figure 15. Jump Pump™ and Battery Charger Connection..... 16
 Figure 16. Jump Pump™ Power Switch 16
 Figure 17. Attached Banners..... 17
 Figure 18. Additional Rope Inspections 25
 Figure 19. Single Wire Inspection Criteria for the Auto-Belay Wire Ropes. 28

Figure 20. Ultimate Bungee™ Stickers 31

Figure 21. Auto-Bungee® Stickers 32

Figure 22. Safety Warning..... 33

Figure 23. Ultimate Bungee™ Rules 34

Figure 24. Hyrdraulic Lift Switch..... 37

Figure 25. Using the Utility Pole..... 39

Figure 26. Attached Carabiner (1)..... 39

Figure 27. Attached Carabiner (2)..... 40

Figure 28. Floating Center Pulley..... 40

Figure 29. Removing the Brace Rod U-Clip..... 41

Figure 30. Lining up the Brace Rod and Connection Point..... 42

Figure 31. Connecting the Auto-Bungee® Cables 43

Figure 32. Accessories & Parts Order Form 55

Figure 33. Breakway Switch Wiring Schematic 58

Figure 34. TAP Molded Cables (Wiring)..... 59

Figure 35. Wiring Diagram for Bargman 7 and 9 Circuit (12V Electrical Connectors) 60

1. INTRODUCTION

Thank you for purchasing a quality-built climbing product from Spectrum Sports Intl. We take pride in our products and believe that we build the best products in our industry. Our philosophy is centered on a commitment of excellence in meeting the needs of our customers and providing quality products that are safe, exciting, and profitable. We encourage you to likewise develop a standard of quality and service.

What makes our team successful is:

- ✓ Commitment to a proper, effective, and profitable design.
- ✓ Third Party Engineering on all our products.
- ✓ Manufacturing our products according to the “ASTM F-24” amusement industry safety standards.
- ✓ Testing designs before they are put into use and sold.
- ✓ Maximum customer through-put, generating high profits.
- ✓ Building quality products, which means the ownership costs are lower.
- ✓ Experience and leadership in the industry.
- ✓ In-house assembly on all our products (this provides for exceptional Quality Control).

Your part in building a successful business using Spectrum Sports Intl products is to:

- Have a commitment to safe operation.
- Have consistent inspections for needed maintenance.
- Effectively and actively market and promote the product.
- Use Spectrum Sports Intl certified replacement parts.



Attention!

Always remember to follow all safety guidelines and use caution while operating your product.

Spectrum Sports Intl is a company that has designed the following products: Climb-N-Dangle®, Drop-A-Rock®, Grip-A-Rock®, RidgeLine®, Climb-N-Challenge®, Klime Wallz®, Coconut Tree Climb®, and Mobile Zipline. This manual will be used to document the operating procedures and safety warnings associated with the Ultimate Bungee™.



Attention!

The guidelines in this manual must be read and understood by ALL Ultimate Bungee™ personnel.

Copyright© Spectrum Sports Intl

Reproduction or translation of any part of this work beyond that permitted by Section 107 or 108 of the 1976 U.S. Copyright Act without permission of the copyright owner is unlawful. Requests for permission or further information should be addressed to Spectrum Sports Intl. Spectrum Sports Intl may make periodic additions, deletions, and modifications to this manual. This manual must be kept up to date, and should reflect all updates currently in use. Please check www.spectrumsports.com or call toll free (435) 792-3883 for updates and/or safety issues regarding your Ultimate Bungee™.

1.1 Receipt & Acknowledgment

This owner/operator's manual is an important document intended to help you become acquainted with the Ultimate Bungee™.



Attention!

Please read the following statement and contact Spectrum Sports Intl, in writing, if the intent of this document is unclear or questions arise. YOU SHOULD NOT OPERATE THE PRODUCTS MENTIONED IN THIS MANUAL IF YOU DO NOT FULLY UNDERSTAND HOW TO OPERATE THEM SAFELY!

“As an owner, I have received, and read, my copy of the Ultimate Bungee™ Owner's Manual. I understand that the information outlined in this manual is subject to change at the sole discretion of Spectrum Sports Intl at any time. It is further understood that as an owner of the Ultimate Bungee™, I have the responsibility to ensure that the correct and latest version of the manual is being used.

As an owner of the Ultimate Bungee™ or authorized representative, it is my responsibility to keep this manual up-to-date with any changes that are made by Spectrum Sports Intl. In addition, if there is anything about the product and/or this manual that is unclear or not understood, it is my responsibility to seek clarification and not use the product until the issue is understood.

Unless informed in writing, Spectrum Sports Intl assumes that the customer understands the Ultimate Bungee™ product and that there are no questions regarding the product and/or the contents of this document, use of the product, or how to operate this product.”

It is the sole responsibility of the customer to clarify any question or concern with Spectrum Sports Intl before use and/or operation.

1.2 Manual Overview

This manual is an introduction to the Ultimate Bungee™ and its operation. The purpose of this manual is to provide a compilation of information that will assist you in proper and safe operation.

The philosophy of Spectrum Sports Intl is centered on a commitment to excellence in meeting the needs of its customers and associates by providing them with the enclosed information.

This manual is designed to provide the product owner with the information, tips, and techniques that will help the owner and employees operate the Ultimate Bungee™ as effectively and safely as possible. This manual is in no way a total representation of all facts related to the product or equipment. Safe operation of this product is the sole responsibility of the wall owner/operator. Good and reasonable judgment must be used when traveling, promoting, and/or operating the product.

1.2.1 Revisions

Spectrum Sports Intl may make periodic additions, deletions, and modifications to this manual. These updates will, in the judgment of Spectrum Sports Intl, add to the quality of services offered. This manual must be kept up-to-date and should reflect all updates currently in use.





Attention!

Please check the following website for updates and/or safety issues regarding your Ultimate Bungee™ www.spectrumsports.com.

1.2.2 Warning Signs

The following warning signs will appear throughout this manual:

Table 1. Warning Signs

SYMBOL	WARNING NAME	DESCRIPTION
	Attention	This icon and font will be used to draw attention to important tips or setup procedures.
	Warning	This icon, and font, will be used to draw attention to important safety warnings.



Attention!

Spectrum Sports Intl will not warranty or stand behind any Ultimate Bungee™ system, that we have manufactured, that does not use genuine and/or authorized replacement parts and/or cables. Any work and/or services that are performed on any Spectrum Sports Intl Ultimate Bungee™ systems that are not performed by an authorized Spectrum Sports Intl employee, voids any and all claims to any manufacturer's liability.

Read and understand this manual before installing and/or operating the product.



Warning!

Climbing and/or failing to comply with the information in this manual may result in serious injury or death.

1.3 Product Overview

Welcome to Spectrum Sports Intl Ultimate Bungee™ product. As the originators and inventors of the Ultimate Bungee™ and the products mentioned in this manual, Spectrum Sports Intl products are industry leaders in innovation, safety, design, and customer satisfaction. Spectrum Sports Intl designs their products for the amusement, entertainment, climbing, and recreation industries. Because of this, the products are engineered with safety, customer appeal, and customer through-put in mind. The Ultimate Bungee™ is designed and manufactured according to the ASTM F24 standard for amusement devices. All products have an Engineering Certified stamp from 3rd party Engineering firms.

NOTE: For full ASTM F24 compliance, it is the owner's responsibility to adhere to specific practices.

1.4 Accident Reporting

Spectrum Sports Intl requires that any and all accidents are reported within 48 hrs from the time of the accident. We need the following information:

- Name of the injured.
- Place of the accident.
- An incident report.
- The route the accident occurred on.
- A description of the accident.
- A description of the proposed product failure.
- The employee's name.

- Daily inspection report/checklist.
- Date the employee was trained on the use of the product.

More info may be required at a later time.

Email or fax a report to: sales@spectrumsports.com or 435-792-3884.

1.5 Certifications / Standards

Spectrum Sports Intl has the following certifications and meets/exceeds the following industry standards:



1.5.1 ASTM Requirements for Owner/Operator Responsibilities

“Owner/operators of amusement rides or devices shall have an inspection program consistent with the inspections outlined in Practice F 853 & Practice F 770. Inspection documents deemed appropriate by the owner/operator to be maintained in the ride file shall be filed in accordance with the procedures outlined in Practice F 770 and Practice F 853. The owner/operator of an amusement ride or device shall promptly notify the manufacturer of an incident, failure, or malfunction which, in his judgment, seriously affects the continued proper operation of the ride or device and is information of which the manufacturer should be aware.”

(Ref: ASTM International Standards on Amusement Rides and Devices: 7th Edition, Sections: 5.2.1-5.2.3)

1.5.2 Engineering Approval

Our products have been designed and reviewed by 3rd party engineers that stand behind the product design. If it is necessary that you receive a copy of the engineering analysis, Spectrum Sports Intl will provide a copy contingent upon the signing of a “non-disclosure/non-compete agreement” and a small fee.

Please call Spectrum Sports Intl for details.



Attention!

The customer is responsible for finding what current codes are required to operate each Spectrum Sports Intl product within their state.

2. PRODUCT SETUP

This section of the manual will provide you with a 13-step process for setting up the Ultimate Bungee™ product. The 13 steps for setup can be seen below.

1. Locate a safe setup area.
2. Remove the trailer from the vehicle.
3. Stabilize the trailer.
4. Remove fencing from racks.
5. Reposition the Auto-Bungee® cable.
6. Raise the support arms.
7. Install aluminum poles.
8. Attach ropes and bungees.
9. Raise aluminum poles.
10. Turn on the master power.
11. Attach banners.
12. Inflate jump pods.
13. Position the fencing.

2.1 Identify a Safe Operating Area

Complete the following steps to identify a safe operating area:

1. You will need a 36'L x 36'W x 22'H area.
2. Consider allocating extra space for a queue line.
3. Operate on level and dry ground.
 - a. Grass, gravel, dirt, asphalt, and concrete are acceptable.
4. Verify that the area is free of overhead power lines.
5. Do not operate in adverse weather conditions.
 - a. No winds over 30mph.
 - b. No lightning.

2.2 Remove the Trailer

Complete the following steps to remove the trailer from the towing vehicle:

1. Unplug the 7-pin electrical plug.
2. Unhook the safety chains and safety brake wire.
3. Remove the trailer coupler pin and slide it to the open position.
4. Turn the handle on the front jack until the coupler is free of the ball hitch.
5. Pull the vehicle away from the trailer

2.3 Stabilize the Trailer

Complete the following steps to stabilize the trailer:

1. Use the four corner jacks to stabilize and level the trailer.
2. Remove the pull-pin and pivot the jacks to the vertical position.
3. Replace the pin.
4. Crank the jack handle until the legs make firm contact with the ground.



Figure 1. Trailer Crank Handle

5. Stabilizing jacks may be used to level the trailer from front-to-back and side-to-side.
6. Tires must remain in contact with the ground.

2.4 Remove the Fencing

If fencing is stored on the trailer, carefully remove it from the racks and set aside. You will need to leave space on both sides of the trailer for installing the aluminum poles, rigging, and jump pods before setting up fencing.

2.5 Reposition the Auto-Bungee® Cable

Remove travel straps. Before proceeding with setup, you must reposition the Auto-Bungee® cables. Simply hang the cable over the side of the trailer. For the rear station, hang the cable over the rear bumper of the trailer.



Figure 2. Repositioning the Auto-Bungee® Cable

2.6 Raise the Support Arms

There are support arms on each side of the trailer. These arms hold the aluminum poles in place. They also support the aluminum poles while in the operating mode.



Warning!

THESE ARMS ARE SPRING LOADED WITH A GAS SHOCK! When you pull the pin they will immediately swing upward, and could potentially hit you in the face.



Figure 3. Releasing the Support Arms

2.6.1 Outside Arms (4 QTY)

Complete the following steps to raise the 4 outside support arms:

1. Remove the R-clip from the bent-pull pin to free the support arm.
2. Pivot the arm slightly outward to clear the pole storage mount.
 - a. Replace the bent-pull pin and R-clip in the pole storage mount hole or set aside.
 - b. This pin will be used in a later step to pin the aluminum pole into position.
3. Reposition the outside support arm and brace rod.
 - a. Remove the U-clip from the brace rod on the support arm.



Figure 4. Removing the U-Clip

- b. Swing the support arm outward until you line up the brace rod with the higher connection point.



Figure 5. Lining up the Brace Rod

- c. Reconnect the brace rod to the support arm with the U-pin.
4. Allow the support arm assembly to rise to the fully extended position.



Figure 6. Fully Extended Support Arm

5. Repeat for these steps for the other three outside arms.

2.6.2 Center Arms (2 QTY)

Complete the following steps to raise each of the center support arms:

1. Remove the R-Clip from the bent-pull pin to free the support arm while holding it in place.
2. Allow the support arm assembly to rise to the fully extended position.
3. Replace the bent-pull pin and R-clip in the pole storage mount hole or set it aside.

2.7 Install the Aluminum Poles

Each pole installs in a specific location. Match the color-coded sticker on the pole with the sticker on the lifting pivot.

NOTE: Install the outside poles first so that you don't have to cross over the middle pole when it is installed.

1. Using two people, remove the pole from the rack on the trailer.

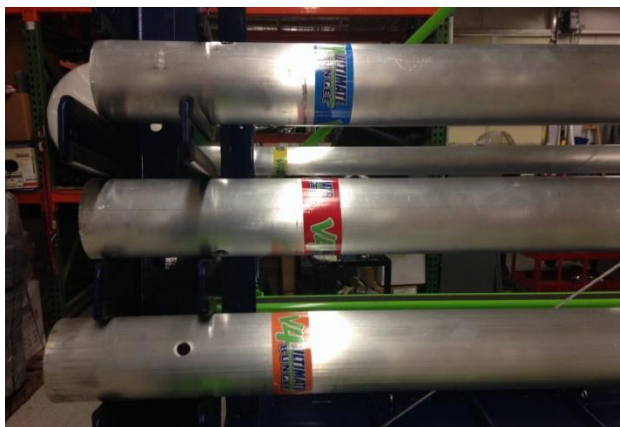

Figure 7. Aluminum Poles on Rack

SPECTRUM SPORTS INTL

3785 N. HWY 91 | Hyde Park, UT 84318 | 888-563-0163

2. Find the mount on the lifting pivot with the matching color-coded sticker.



Figure 8. Matching the Aluminum Poles to the Mount

3. Install the pole.
4. Verify that the locking mechanism located halfway up the pole has the beveled edge facing upward.



Figure 9. Beveled Edge of the Aluminum Pole

5. Pin the pole in place using the bent-pull pin and R-clip from section 2.6 (the bent-pull pin and R-clip that previously held the support arms in position during travel).
6. Repeat these steps for each pole.

2.8 Attach the Ropes & Bungees

Each jump station has a rope that runs horizontally between each pole. A set of bungees attaches to each end of that rope. The center of the rope is rigged to the steel cable coming from the Auto-Bungee® on the trailer.

1. Attach the ropes:
 - a. Attach the outside rope pulley to the end of the pole using a rated steel carabiner.



Figure 10. Attached Rope Pulley

- b. Attach the inside rope pulley to the end of the center pole.

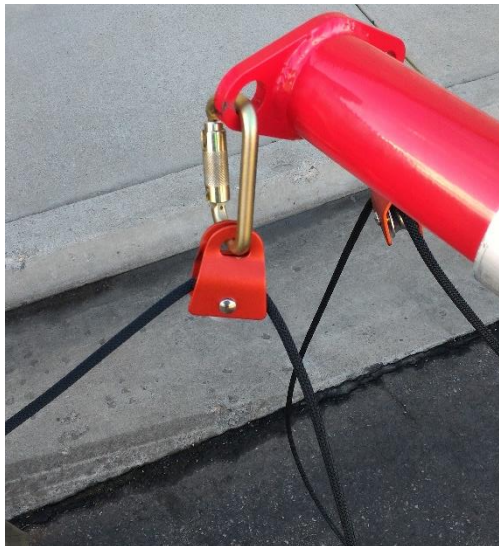

Figure 11. Attached Inside Rope Pulley

- c. Attach the center pulley to the Auto-Bungee® cable with a rated steel carabiner. If the Ultimate Bungee™ has a rear station, no center pulley is needed. The carabineer is all that is required.
- d. Make sure the pulleys are not twisted.



Figure 12. Checking the Pulleys

- e. Repeat this step for each of the stations.

NOTE: If applicable, there is one rope for each pole for the rear station.

2. Attach the bungees:
 - a. Attach a bungee cord assembly to the end of each rope.
 - b. The proper order is: rope, carabineer, bungees, carabineer, swivel, lanyard (doubled over), carabineer, and harness.
 - c. Each station should have four-40 lb. black bungees, four-20 lb. blue bungees, and four-10 lb. bungees. Two of each color, per side of the station.
 - d. Attach bungee cord assemblies to each other using the end carabiner. If applicable, leave the rear station unhooked.
3. Double-check that all pulleys are properly aligned and that the carabiners are securely locked.

2.9 Raise the Aluminum Poles

The aluminum poles are lifted into position using a 12-volt hydraulic lift pump that is powered by the onboard deep cycle 12-volt battery.

1. Double-check for any overhead obstructions such as power lines.
2. Insert the key and turn to the right to activate the hydraulic lift pump.

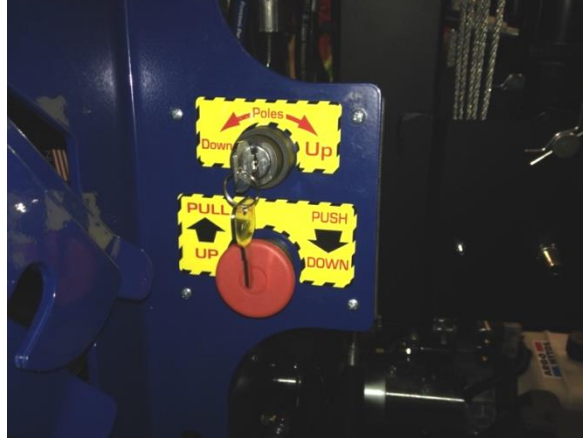

Figure 13. Hydraulic Lift Switch

3. Lift the poles until they lock into the support arms. The 12-volt pump will not automatically stop. You will need to manually release the key switch once the poles are fully extended.



Figure 14. Locking the Poles into the Support Arms

- a. Verify that each pole is latched securely into position.
 - b. Each support arm has been adjusted so that all three poles should latch at the same time. However, they can be adjusted if needed. Adjusting the jacks may help with alignment. Call for more details.
 - c. You can use the included utility pole to give the aluminum pole a slight nudge to get it to lock into place.
4. Repeat these steps on the other side of the trailer.

2.10 Turn on the Master Power

The Master Power Switch is located immediately behind the battery on the inside of the frame. This switch controls the power to the Auto-Bungee® systems.

1. Verify that the red Auto-Bungee® switches are in the down position, or pushed in.
2. Plug in your Jump Pump™ and battery charger. If you have a light kit, it also runs off the 12-volt battery.

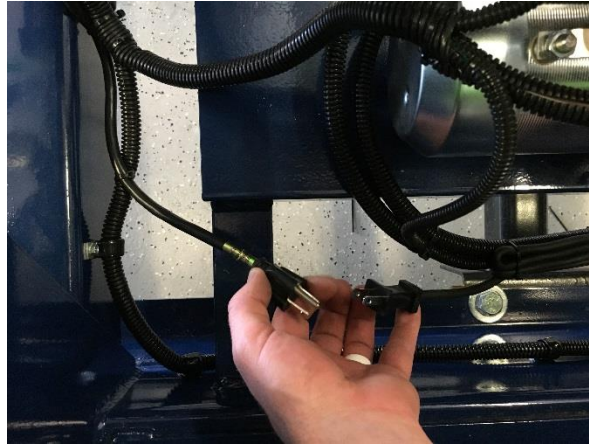

Figure 15. Jump Pump™ and Battery Charger Connection

3. Turn your master power switch to “On” and use the “Mode” button to set your CTEC battery charger to “supply.”



Figure 16. Jump Pump™ Power Switch

The Jump Pump™ and 12-volt power supply must be plugged in during operation.

2.11 Attach the Banners

If banners are being used, they may be attached at this time.



Figure 17. Attached Banners

2.12 Inflate the Jump Pods

Complete the following steps to inflate the jump pods:

1. Inflate the jump pods according to the manufacturer's recommendations.
2. A 110-volt blower is included for inflating jump pods.
3. Center the jump pods directly under each station.

2.13 Trampoline Option

Complete the following steps for the trampoline:

1. Springs are installed properly and are covered with the provided pads.
2. Make sure the trampolines are on level ground.
3. Center the trampolines directly under each station.

2.14 Position the Fencing

Spectrum Sports Intl does not require that fencing is used with this ride. However, many regulatory districts may have this requirement. Operators are asked to comply where applicable.

3. INSPECTIONS

This section of the manual will provide you with guidelines and checklists for daily, weekly, quarterly, and yearly inspections. This section will also provide you with guidelines for other product-related inspections.



Warning!

Inspections of the Ultimate Bungee™ and Auto-Bungee® must occur on a daily, monthly, and annual basis to ensure continued safe operation. These guidelines are a minimum. Take caution to ensure that any and all working parts and safety related products are thoroughly inspected and that all bolts and pins are secure before use.



Attention!

All of the information in this chapter of the manual must be understood and implemented. All of the inspections listed in this section must be performed within the time frames specified by this manual.

3.1 Inspection Checklists

3.1.1 Quick Reference Checklist

Table 2. Quick-Reference Checklist

QUICK REFERENCE FOR INSPECTIONS			
INSPECTION ITEM	DAILY	MONTHLY	ANNUALLY
Trailer Pre-Trip	✓		
Onsite Operating Conditions	✓		
Rigging	✓		
Hardware	✓		
Auto-Bungee®	✓		
Jump Pods	✓		
Bungee Cords	✓		
Visually Inspect Aluminum Poles		✓	
12v Hydraulic Lift System		✓	
Frame Inspection		✓	
Clean Trailer		✓	
Grease Pivots & Jacks		✓	
Repack the Wheel Bearings			✓
Replace the Auto-Bungee® Cables			✓

3.1.2 Daily Inspection Checklist

Table 3. Daily Inspections Checklist

ULTIMATE BUNGEE™™ DAILY INSPECTIONS CHECKLIST	
Operator:	
Date:	
TRAILER PRE-TRIP	
	Inspect the hitch and locking pin to ensure that it is in working order and engaged.
	Ensure that the 7-pin plug is inserted and DOT lighting (brakes, blinkers, and running lights) are working.
	Check the lug nuts to ensure that they are properly torqued.
	Check the air pressure in each tire (see tire for recommended pressure).
	Confirm that all cargo, including poles, jump pods, fencing, and other are secured for transit.
ONSITE OPERATING CONDITIONS	
	Level and dry ground, free of overhead obstructions, winds under 30 mph, & no lightning.
RIGGING	
	Aluminum poles are pinned at the bottom and support arms are latched around mid-point.
	Inspect aluminum poles for cracks, bends, or other deformations.
	Removable pulleys are aligned correctly and connecting carabiners are securely locked.
	Inspect ropes for core or sheath damage; knots have a minimum of 2" tail (replace them if needed).
	Inspect bungees for tears, excessive weather checking, and other damage (replace them if needed).
	Inspect lanyards for excess fraying or undone stitches (replace them if needed).
	Inspect harnesses for excess fraying or undone stitches (replace them if needed).
HARDWARE	
	Inspect pulleys for damage, deformation, and ensure they spin freely.
	Inspect carabiners for grooving and rust. Ensure that the gate snaps shut and locks automatically.

ULTIMATE BUNGEE™™ DAILY INSPECTIONS CHECKLIST	
	Inspect swivels for grooving and rust. The joint should pivot smoothly with little vertical play.
JUMP PUMP & AUTO-BUNGEE®	
	Oil is visible in sight glass on the Jump Pump
	Visually inspect cable according to the parameters found in the Owner's Manual.
JUMP PODS	
	Ground is free of debris that may damage the jump pods.
	Inspect the jump surface for wear (rips, tears, runs) and replace them, if needed.
	Confirm that jump pods are fully inflated.
TRAMPOLINE	
	Tramp is assembled per manufacturer specifications.
	Set up on a flat level ground.
	All pad's are installed to the cover springs.
HARNESSES	
	All buckles are working properly.
	No visual rips or tears, no torn stitching.

3.1.3 Monthly Inspection Checklist

Table 4. Monthly Inspections Checklist

ULTIMATE BUNGEE™ MONTHLY INSPECTIONS CHECKLIST	
Operator:	
Date:	
	Complete the Daily Inspections Checklist.
INSPECT THE 12v HYDRAULIC LIFT SYSTEM	
	Visually Inspect for oil leaks around the rams, hoses, and fittings.
	Test the 12v battery. Charge it, if needed.
FRAME INSPECTION	
	Check all upper frame assembly bolts using a wrench to ensure that they are tight.
	Visually inspect all structural components and welds for damage, deflection, or cracking.
CLEAN THE TRAILER	
	Use a mild detergent and pressure washer. DO NOT use high pressure on the hydraulic rams, hoses, fittings, tank, power switch, or battery areas.
GREASE THE TRAILER	
	Grease the six zerks found on the two large lifting pivots.
	Grease the zerks found on all five jacks.

3.1.4 Annual Inspection Checklist

Table 5. Annual Inspections Checklist

ULTIMATE BUNGEE™ ANNUAL INSPECTIONS CHECKLIST	
Operator:	
Date:	
	Complete the Daily Inspections Checklist.
	Complete the Monthly Inspections Checklist.
GREASE THE WHEEL BEARINGS	
	Repack the wheel bearings with grease.
REPLACE THE FOLLOWING PARTS	
	Steel cable on each Auto-Bungee® device.
	Any other parts, as deemed necessary by inspection. When in doubt, change it out.

3.2 Rope Inspections



Warning!

Please read this before using any fiber rope. The improper use of rope is DANGEROUS. Fiber rope will fail if it is worn, damaged, abused, overloaded, or improperly maintained. ROPE FAILURE CAN CAUSE SERIOUS INJURY OR DEATH!

NOTE: There are many standards and guidelines for the use of rope in specific applications. If you have any questions or concerns, please contact:

***Cordage Institute
994 Old Eagle School Road
St. 1019,
Wayne, PA 19087-1866
Tel: 610-971-4854
Fax: 610-971-4859
Email: info@ropecord.com***

Follow these rules to safely use and take care of the ropes:

- The USER is responsible for determining the suitability of a rope for specific applications.
- KNOW the working load limit (WLL) of your rope (get the WLL from a manufacturer or supervisor).
- DO NOT exceed the WLL or shock load.
- ONLY USE rope that is in good condition (no cuts or pulled strands).
- DO NOT stand within the recoil (snapback) area.
- DO NOT use over rough surfaces without chaff protection.
- USE sheaves with a minimum of 8 times the rope diameter.
- DO NOT bend the rope around unprotected, sharp corners.



Make sure your rope size is adequate for the job. **DON'T USE TOO SMALL A ROPE.** A table of specifications is available from your dealer, distributor, or the manufacturer.



Keep rope clean. Don't drag rope over ground or other rough gritty surfaces. This allows abrasive particles to work into the rope and damage fibers.



Uncoil rope properly. Lay coil flat with Inside end of rope nearest the deck. Loosen lashings and covering. Reach down through center of coil and pull rope up through from inside the coil.



Prevent kinks, which cause permanent damage and weakening of the rope. If rope is continually twisted in one direction, as over a winch, counteract by throwing in twist in opposite direction.

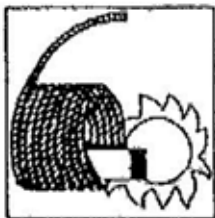

Dry rope before storing. Manila ropes mildew and decay if stored wet; a cool, dry room with free air circulation provides the best storage. Do not store in direct sunlight.



Protect rope from chemicals such as acids, alkalis, oils, paints and other agents not chemically neutral.



Reverse rope ends regularly, particularly when used in tackle. This permits even wearing and assures longer useful life.



Avoid sudden strains. Shock loading, as jerking, may cause failure of a rope normally strong enough to handle the load. When using tackle or slings, apply a steady, even pull to get full strength from rope.

CAUTION: Heat can seriously affect the strength of synthetic ropes. The temperature at which a 50% strength loss can occur are:
 Polypropylene: 200 F Nylon: 300 F Polyester: 350 F
 Kevlar/Technora: 400 F Dyneema/Spectra: 150 F

Figure 18. Additional Rope Inspections

3.2.1 Wire Rope Inspection Comparison

A wire rope inspection criteria comparison can be seen in the table below:

Table 6. Wire Rope Inspection Comparison

INSPECTION CRITERIA REQUIRING ROPE REPLACEMENT	ASME/B30.5C CRANES	WIRE ROPE USERS GUIDE, 3 RD EDITION
Length of Wire Rope Service	No specifications given.	No specifications given.
Abrasion	1/3 diameter worn on any wire (see below).	1/3 diameter worn on any wire, see specific governing code.
Rope Stretch	No specifications given.	When the rate of stretch increases after initial break-in period.
Reduction in Rope Diameter	1/48" on cables 1/4" diameter.	When accompanied with significant rope stretch; otherwise not specific.
Corrosion	Not specified.	If accompanied by metal pitting; if rust exists.
Kinks, Twists, Crushing	Any – replace wire rope.	Any – replace unless cable is repairable.
“Bird Caging”	Any defect – replace unless defect can be removed.	Any defect – replace unless defect can be removed.
Heat/Electrical	Any – replace wire rope.	If wires are fused or discolored.
Broken Strands	Rotation resistant ropes: 2 wires in 6 rope diameters – and 4 wires in 30 rope diameters. New criteria: 4 broken wires in one lay-length and 2 broken wires within 1 strand within 1 lay-length.	See specific code.
Damaged End Attachments	If non-repairable, replace wire rope.	See specific code.
Non-destructive	Not specified	Not specified.

The ASME/B30.5 inspection criterion is very specific on the visual inspections required. The code is specifically designed to allow an inspector to accurately infer the status of the wire rope core from a thorough inspection of the wire ropes broken wires in a strand, abrasion of the wires in the strands, and the change in the diameter of the overall rope. The inspection criterion requires a thorough visual inspection of the rope.

The number of broken strands is a key aspect of all of the ASME codes. Due to the primary role it plays in determining the integrity of the rope core, a summary of the ASME code allowable broken strands can be seen in the table below.

Table 7. Allowable broken strands by ASME Code

ASME STANDARD	EQUIPMENT CONNECTION	NUMBER OF BROKEN WIRES IN RUNNING ROPES		NUMBER OF BROKEN WIRES IN STANDING ROPES	
		IN ONE		IN ONE	
		ROPE LAY	STRAND	ROPE LAY	STRAND
ASME/B30.2	Overhead & Gantry Cranes	12**	4	Not Specified	
ASME/B30.4	Portal, Tower, & Pillar Cranes	6**	3	3	2
ASME/B30.5	Crawler, Locomotive & Truck Cranes: Retirement criteria based on number of broken wires rev B. Rotation Resistant Rope found in length of rope equal to 6x rope diameter – 2 broken wires maximum; and 30x rope diameter – 4 broken wires maximum.				
ASME/B30.5	Running Rope	6**	3	3	2
ASME/B30.6	Derricks	6**	3	3	2
ASME/B30.7	Base Mounted Drum Hoists	6**	3	3	2
ASME/B30.8	Floating Cranes & Derricks	6**	3	3	2
ASME/B30.16	Overhead Hoists	12**	4	Not Specified	
ANSI/A10.4	Personnel Hoists	6**	3	2**	2
ANSI/A10.5	Material Hoists	6**	Not Specified		

****Also remove for 1 valley break**

3.3 Cable Inspections

A rigorous inspection routine is not only recommended, but required. Proper inspection will eliminate the chance of using a wire rope beyond its useful life. The inspection routine listed is the procedure that should be followed rigorously. This inspection method is visual and adheres to the applicable standards published in the United States.

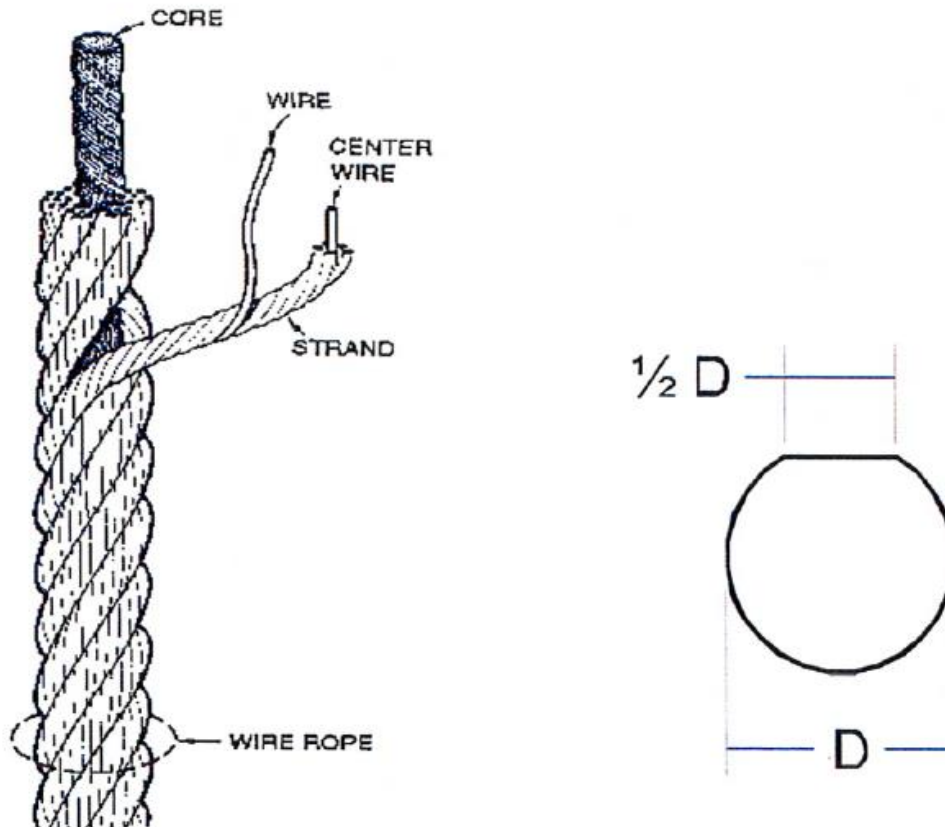

Figure 19. Single Wire Inspection Criteria for the Auto-Belay Wire Ropes.

3.3.1 Replacing the Cable

Replace the cable if any of the following conditions are true (refer to the previous figure):

1. If any of the individual wires in a strand have a flat spot of more than $\frac{1}{2}$ the diameter of the smallest wire as shown in the figure above.
2. If there is a single broken wire in any strand.
3. If there are 50,000 or more cycles on the route.
4. If the cables have been on a climbing tower for 1 year (12 months).
5. If there are any twists, kinks, flat spots, or bird-caging.

Wire Rope Inspection Criteria recommended by various agencies, manufacturers, and governing agencies in the United States have published guidelines pertaining to wire rope use, maintenance, inspection, and general specifications. Most wire rope manufacturers have additional guidelines for

the use, maintenance, and inspection of their cables. These guidelines and codes set precedence for the industry standard methods of wire rope use, maintenance, and inspection. Deviation from these recommendations would be viewed as questionable by the most experienced engineers in the industry.

To justify the inspection method recommended by Spectrum Sports Intl, the most noted codes and guidelines have been obtained and read by SAE Inc. engineers. The codes obtained by SAE Inc. engineers include:

- ASME (American Society of Mechanical Engineers) International Publication. ASME/B30.5c – Mobile and Locomotive Cranes, 1998, ISBN#: 0791822753
This code is a revision of the ASME/ANSI B30.5-1989. It applies specifically to applications similar to the Space Shot™ ride.
- Wire Rope Technical Board
Wire Rope User’s Manual, Third Edition, 1993
This test gives a summary compilation of the recommended practices for wire rope use in general applications.
- OSHA Wire Rope Excerpts – General Standards, Vol. 37, Number 202, Oct. 1972.
This general standard is a compilation of the ASME/ANSI standards that exist now as the SME/B30.XX series. These are the forerunner to current standards.
- Leeschen Wire Rope Company – “Wire rope Inspection”, Report #107.
This report gives guidelines to the inspection methods appropriate to identify wire rope damage.

Each of these codes specifies, in general, the same criteria for the inspection of wire ropes. Additional ASME codes specify inspection criteria for additional applications including, but not limited to, personnel hoists (elevators), overhead cranes, material hoists, etc. The ASME code governing *Mobile and Locomotive Cranes* is very stringent. It is the most stringent code that has any applicability to the Auto-Belay. The highlights of the inspection guidelines/codes listed above are included in the next table of this document to set a comparison reference for Spectrum Sports Intl guidelines.

Note: The inspection procedures outlined in the referenced codes are all *visual inspections*.

3.3.2 Cable Replacement Options

The following cable replacement options are available:

- **On-Site Service:** Spectrum Sports Intl has offered the option of On-Site Service for over a decade. Our service truck is fully equipped and circles the entire country twice each year. The On-Site Service option may include cable replacement, parts replacement, inspections, and any other maintenance needs pertaining to the customer’s request.
To be put on the On-Site Service schedule: fill out and submit a service request form at www.spectrumsports.com or call (435)792-3883
- **Self-Installation:** Customers who wish to install cables on their own product have the option of ordering certified cable, with both ends crimped, straight from our facility.

3.4 Non-Destructive Examination (NDE) Inspection Policy

Spectrum Sports Intl has had a third party structural analysis for all of our products since 2004. These analyses call out for “visual inspections” for specific items.

Spectrum Sports Intl requires visual inspections of the applicable items as called out in the “Inspections” section of this product owners/operators manual.



Attention!

The documented daily, weekly, quarterly, and annual inspections must be completed to ensure safe operations of all products.

Ultimate Bungee™ and Auto-Bungee® stickers can be seen on the following two pages. These stickers will be followed by the Safety Warning and Rules signs associated with the Ultimate Bungee™ and Auto-Bungee®.

3.5 Ultimate Bungee™ Stickers

Be aware of the location of these stickers and follow their instructions:

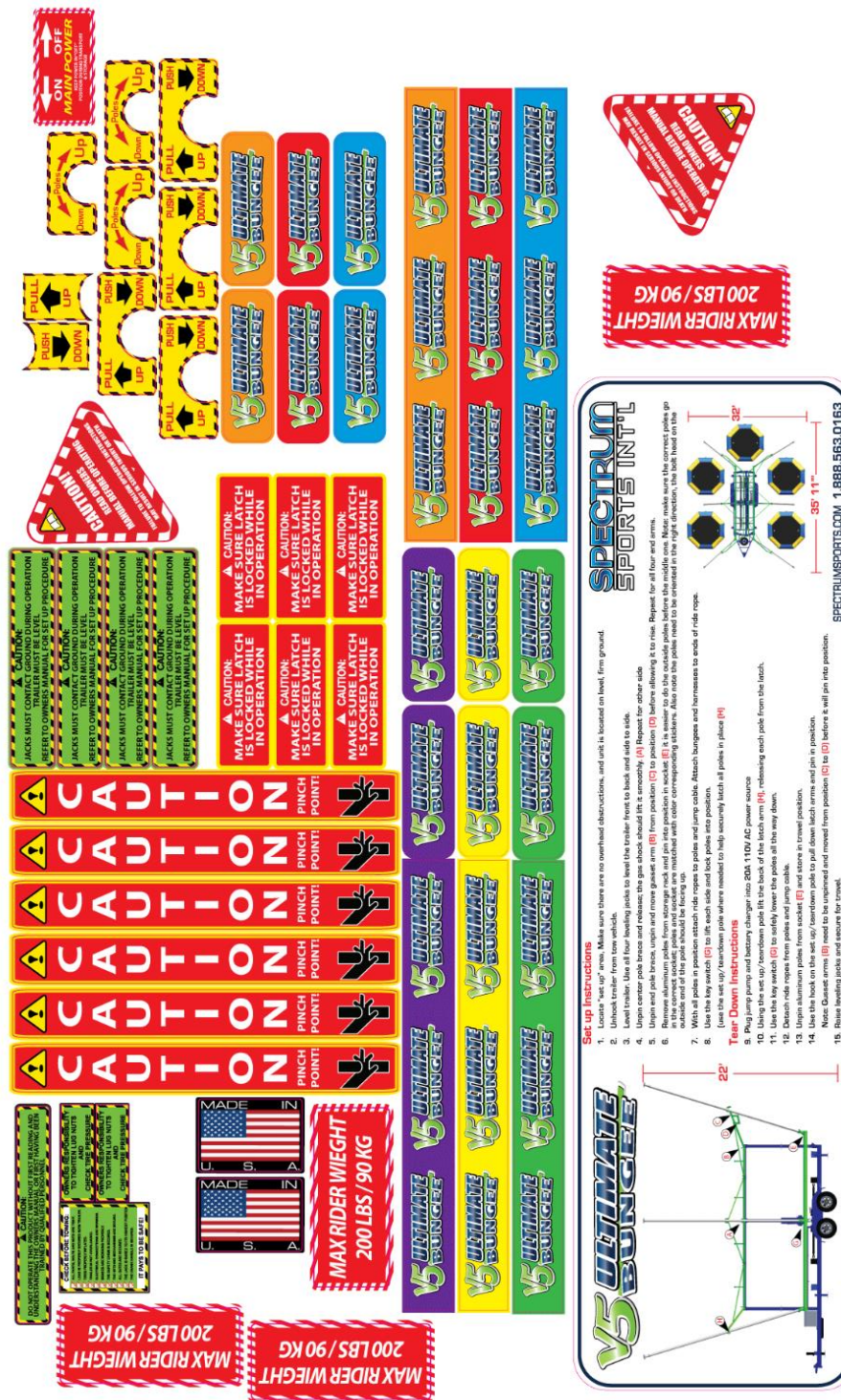

Figure 20. Ultimate Bungee™ Stickers

SPECTRUM SPORTS INTL

3785 N. HWY 91 | Hyde Park, UT 84318 | 888-563-0163

3.6 Auto-Bungee® Stickers



Figure 21. Auto-Bungee® Stickers



Figure 22. Safety Warning



Figure 23. Ultimate Bungee™ Rules

4. OPERATIONS

Two operators are required to operate the Ultimate Bungee™.

Jump Masters - The role of the Jump Master is as follows:

- Knows and understands how to safely **transport** the Ultimate Bungee™.
- Knows and understands how to **setup** the Ultimate Bungee™.
- Knows and understands how to **inspect** the Auto-Bungee® Safety System and Ultimate Bungee™.
- Knows and understands how to **take-down** the Ultimate Bungee™.
- Keeps the queue line and harness area in order.
- Collects any tokens, tickets, or money for the Ultimate Bungee™ ride.
- Verbally explains to the jumpers the items on the Warning and Rules signs.
- Harnesses the jumpers.
- Connects jumpers to the bungees and gives any final instructions.
- Controls the cycle time of jumpers.
- Ensures that the Auto-Bungee® Safety System is properly retracting the bungee assembly with each user.



Warning!

Ultimately it is the Jump Master's responsibility to ensure that each Ultimate Bungee™ jumper has a safe and enjoyable experience.

4.1 Rider Restrictions

The following rider restrictions apply to the Ultimate Bungee™:

- The jumper must weigh between 40 lbs. – 200 lbs. (18kg – 91kg).
- Minimum height for a jumper is 40" tall.
- Minimum age for jumper is 6 years old.
- One jumper allowed per station (4-5 jumpers total, depending on model of Ultimate Bungee™).
- Long hair must be secured.
- Riders cannot be under the influence of any substance.
- Riders must be able to follow all verbal instructions from the operators.
- Riders are prohibited if they have health problems such as head, neck, back, or limb injuries; a heart condition; or are pregnant.
- Riders must have sufficient limbs to wear a full-body harness.

4.2 Ride Cycle

The following ride cycle applies to the Ultimate Bungee™:

1. Jumper enters the queue line.
2. Any tokens, tickets, or money are collected, if applicable.
3. Jump Master verbally explains the Warning and Rules Sign.
4. Jumper confirms that they understand the Warning and Rules Sign.
5. Jumper is harnessed as follows:
 - a. 22" – 30" waist: Red Kids Harness
 - b. 30" – 40" waist: Blue Adult Harness
6. Jumper climbs onto the jump pod.
7. A bungee assembly is connected to each side loops on the jumper's harness.
 - a. Adjust bungees on each side to equal half the rider's weight plus approximately 20%.
 - b. Use equal amounts of bungees on each side.
 - c. **Always use at least 2 bungees on each side!**

Table 8. Jumper Weight and the Associated Bands per Side

Jumpers Weight (lbs)	Bands per side		
	10 lb.	20 lb.	30 lb.
40	2	1	-
50	-	2	-
60	1	-	1
70	2	-	1
80	-	1	1
90	1	1	1
100	2	1	1
110	-	-	2
120	1	-	2
130	2	-	2
140		1	2
150	1	1	2
160	2	1	2
170	-	2	2
180	1	2	2
190	2	2	2
200	2	2	2

NOTE: More fit jumpers will benefit from more bungees.

8. Operator steps off the jump pod to allow the jumper to begin their cycle.
9. Operator engages the Auto-Bungee® by pulling out the button.

10. Jumper continues until they are tired or out of time.
11. Warn jumper before lowering them. No more flips!
12. Operator disengages the Auto-Bungee® by pushing in the button.
 - a. Jumper automatically lowers to the jump pod.
13. Operator removes the bungee assemblies from each side of the harness.
14. Jumper gets off the jump pod.
15. Operator removes the harness.
16. Jumper exits the ride area.

4.3 Emergency Evacuation Plan

In the event that a jumper becomes stranded in an elevated position, the following emergency evacuation plan is to be implemented:

1. Clear all other jumpers from the area.
2. Release the support arm locks from the aluminum jump poles.
3. Insert the key that controls the setup of the hydraulic lift system and turn to the left to lower the aluminum jump poles.

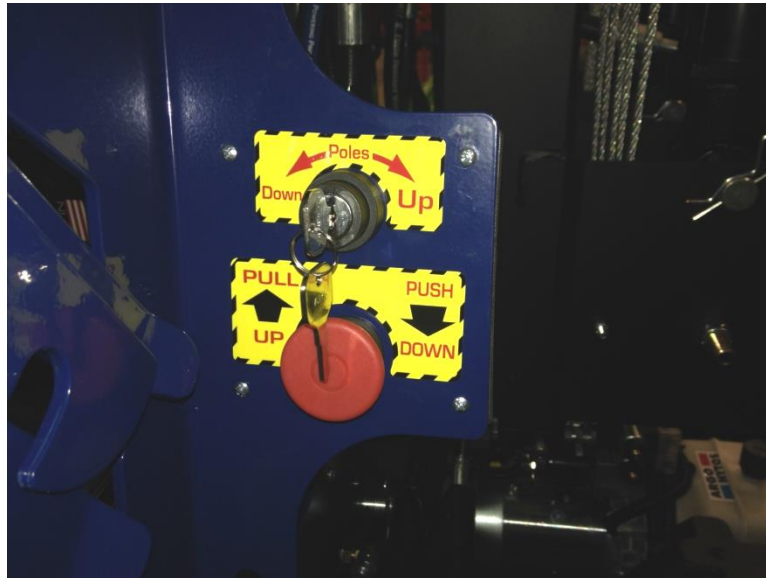

Figure 24. Hydraulic Lift Switch

4. Use caution so that the poles do not strike any objects when lowered.
5. The second Jump Master should reposition the jump pod so that the stranded jumper can be safely lowered onto it.
6. Disconnect the bungee cords from the jumper's harness and evaluate if further action is needed.

5. TAKE-DOWN

This section of the manual will provide you with a 9-step process for taking down the Ultimate Bungee™ product. The 9 steps for take-down can be seen below.

1. Dismantle the inflatable jump pods
2. Remove the banners, if they are used.
3. Dismantle the fencing, if they are used.
4. Lower the poles.
5. Remove the ropes and bungees.
6. Move the poles to the trailer storage rack.
7. Lower the support arms.
8. Reposition the Auto-Bungee® cables for travel.
9. Rack the fencing, if they are used.

5.1 Dismantle the Inflatable Jump Pods

Complete the following steps to dismantle the inflatable jump pods:

1. Deflate and store the inflatable jump pods according to the manufacturer's recommendations.
2. Never store wet!

5.2 Remove the Banners

If the banners were used, and you wish to remove them, use caution when removing the top connection points.

5.3 Dismantle the Fencing

If the fencing was used, set them to the side in order to leave clearance for the aluminum poles when they are lowered.

5.4 Lower the Poles

The aluminum poles are lowered using a 12-volt hydraulic lift pump that is powered by the onboard deep cycle battery.

1. Remove any obstructions directly under the poles.
2. Use the Utility Pole to push up on the U-shape back portion of the support arm latch.



Figure 25. Using the Utility Pole

3. The pole will lunge downward a few inches as it disengages from the Support Arms latch.
4. Repeat for the other poles on the same side of the trailer.
5. When all poles are free from the Support Arm latches, use the key to lower them to the ground. Be sure the area is clear before lowering the poles
6. Repeat for the other side of the trailer.

5.5 Remove the Ropes & Bungees

Each jump station has a rope that runs horizontally between each pole. A set of bungees attaches to each end of that rope. The center of the rope is rigged back to the steel cable on the trailer.

1. Remove each bungee assembly where they attach to the rope via carabiner.
2. Remove the ropes:
 - a. Make sure the Auto-Bungee® button is fully depressed for each route!
 - b. Remove the carabiners and pulleys from the poles.

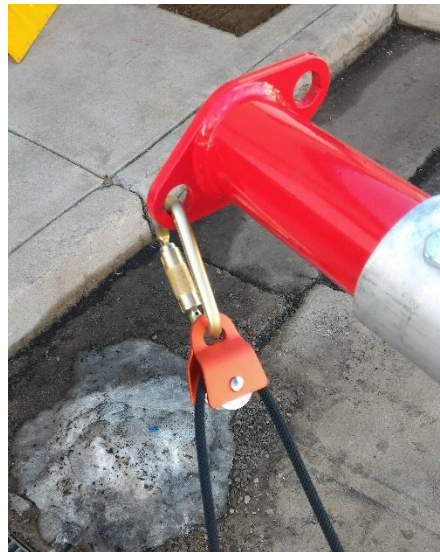

Figure 26. Attached Carabiner (1)

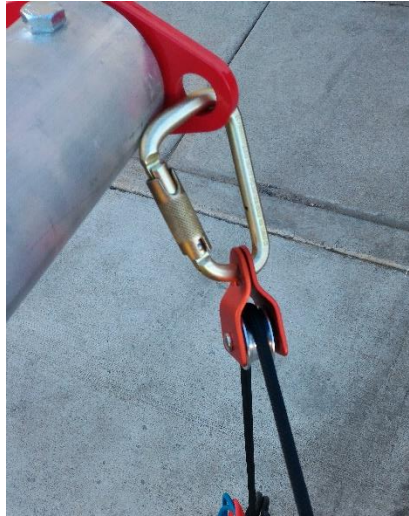

Figure 27. Attached Carabiner (2)

- c. Remove the floating center pulley that connects to the Auto-Bungee® cable with a rated steel carabiner.

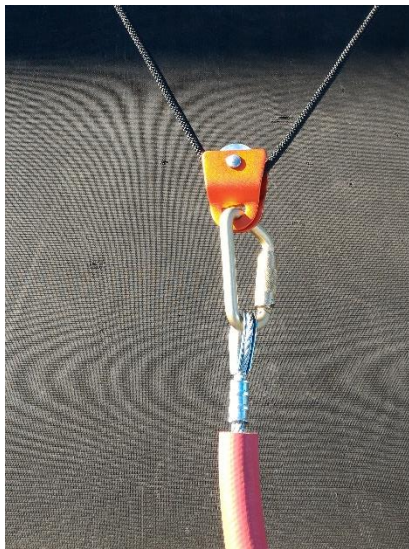

Figure 28. Floating Center Pulley

- d. Repeat for each of the stations.
3. Carefully place the ropes and bungees in the tool box. Keep the ropes and bungees together for simplified setup or take-down. Place each station in a storage bag.

5.6 Moving the Poles to the Storage Rack

Complete the following steps to move the poles to the trailer storage rack:

1. Remove the R-clip and pin from the base of the aluminum poles.
2. Keep these pins nearby as they will be used in the next step to pin down the support arms.
3. Use two people to remove the poles and carefully rack on the trailer.

NOTE: Begin with center poles first.

5.7 Lower the Support Arms

There are three support arms on each side of the trailer. These arms support the aluminum poles while in the operating mode, and they hold the aluminum poles in place while traveling down the road.



Warning!

CAUTION! THESE ARMS ARE SPRING LOADED WITH A GAS SHOCK! As you pull them down they will want to swing upward, and they could hit you in the face. Do not force the arms faster than the shock will allow. This may bend the shock.

5.7.1 Lowering the Outside Arms

Complete the following steps to lower the four outside arms:

1. Use the Utility Pole to reach up and hook around the end of the brace rod.
2. Pull the support arm down to where you can grab it with your hands.
3. Reposition the outside support arm and brace rod.
 - a. Remove the U-clip from the brace rod on the support arm.



Figure 29. Removing the Brace Rod U-Clip

- b. Swing the support arm inward until you line-up the brace rod with the lower connection point.



Figure 30. Lining up the Brace Rod and Connection Point

- c. Reconnect the brace rod to the support arm with the U-pin.
4. Push the Support Arm down into the U-brackets, and pin the arms in place using the bent-pull pin and R-clip from section 5.6.
5. Repeat these steps for the other three outside arms.

5.7.2 Lowering the Center Arms

Complete the following steps to lower the two center arms:

1. Use the Utility Pole to reach up and hook around the end of the brace rod.
2. Pull the support arm down to where you can grab it with your hands.
3. Push the support arm down into the U-brackets, and pin the arms in place using the bent-pull pin and R-clip from section 5.6.
4. Repeat for the other center arm.

5.8 Repositioning the Auto-Bungee® Cables

Complete the following steps to reposition the Auto-Bungee® cables and prepare them for travel:

1. Pull the Auto-Bungee® cables over the pole support rod and clip them together for travel.

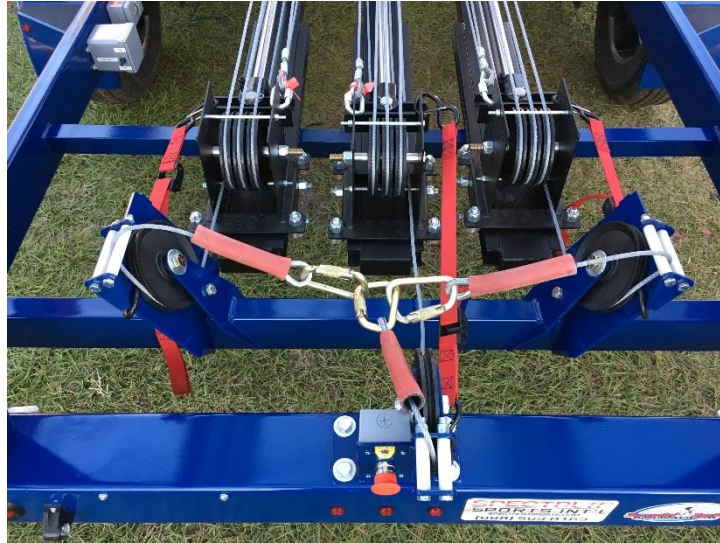

Figure 31. Connecting the Auto-Bungee® Cables

2. Pull the “up” buttons to tighten the cables for travel.
3. Unplug the jump pump from power.
4. Strap the Auto-Bungee® to trailer.

5.9 Rack the Fencing

Complete the following steps to rack the fencing, if it has been used:

1. Use care while placing the fencing on the racks.
2. Secure them tightly before traveling.

6. TRANSPORTATION

This section of the manual will provide you with pre-trip and transportation instructions. The transportation dimensions for the Ultimate Bungee™ are as follows:

- **Length:** 34'6"
- **Height:** 11'6"
- **Width:** 7'6"
- **Weight:** 5,500 lbs.

6.1 Pre-Trip Inspection

Complete the following items before transporting the vehicle:

- Ensure tires are properly inflated.
- Torque lug nuts to 100 ft. lbs.
- Confirm that the spare tire is secure and properly inflated.
- In-line fuses 20-amp min.
- Make sure the hitch pin on the coupler is securely locked.
- Safely tie down inflatable jump pods, blowers, and fencing.
- Raise all jacks in travel position with proper pins in place.
- Adjust mirrors so trailer is seen clearly.
- Ensure that the brakes work properly on both the tow vehicle and the trailer.
- Test to make sure that all lights are working properly on both the tow vehicle and the trailer.
- Walk around the trailer and vehicle, look for any items that may be out of place.

6.2 Connect to the Tow Vehicle

Follow the guidelines in this section to connect the trailer to the tow vehicle.



Attention!

Be sure that you have the appropriate ball on the tow vehicles hitch prior to connecting the tow vehicle to the Ultimate Bungee™.

The Ultimate Bungee™ trailer is designed to be towed level with the ground. An adjustable hitch may be required depending on the height of the tow vehicle. The coupler is adjustable to achieve the best position. The ball hitch should be between 18"-22" from the ground.

- Confirm that your tow vehicle is rated for 5,500 lbs.
- Confirm that you have the appropriate 2-5/16" ball hitch on the tow vehicle.

The following steps are to be followed each and every time the trailer is connected to a tow vehicle:

1. Remove the pin from the trailer coupler and slide it to the open position.
2. Back the tow vehicle until the ball hitch is directly under the trailer coupler.
3. Use the jack on the trailer tongue to lower the coupler onto the ball hitch.
4. Slide the coupler into the closed position and secure with the locking pin.
5. Connect both safety chains to the tow vehicle. Cross the chains and twist to adjust height if necessary.
6. Secure the “brake-away” cable to the tow vehicle.
7. Connect the round 7-pin electrical plug from the trailer to the tow vehicle.

6.2 Transporting the Climbing Tower

It is your responsibility to practice safe driving skills while pulling the Ultimate Bungee™. Be sure to do the following while towing an Ultimate Bungee™:

1. Do not exceed 65 MPH while towing.
2. Do not transport in snow, ice, heavy rain, or if winds exceed 40 MPH.
3. Obey all traffic rules, laws, and speed limits.
4. No texting while towing the Ultimate Bungee™.
5. Make wide sweeping turns.
6. Allow plenty of room for braking.
7. Be aware of the trailer height, width, and length.
8. Plan ahead; reserve plenty of time to get to the event/location.



Attention!

Walk around the perimeter. Inspect for any items that may have been left out.

7. MAINTENANCE

Spectrum Sports Intl will give no warranty or be liable for any of its products, components, or safety systems that do not use genuine and/or authorized replacement parts. Any modifications, alterations, misuse, work, or service that is performed on your Spectrum Sports Intl Ultimate Bungee™ that is not performed by an authorized Spectrum Sports Intl employee voids any and all claims to any manufacturer's liability.

Maintenance must be performed according to the following schedule - no exceptions.

7.1 Maintenance Schedule

Complete all of the items in the following maintenance schedules.

7.1.1 Monthly Maintenance Schedule

Complete the following monthly maintenance items:

- Check and tighten all upper frame assembly bolts.
- Grease the six pivots on the Ultimate Bungee™ structure.
- Grease the five jacks. Perform earlier if jacks become difficult to crank.
- The jump pump has a hydraulic oil filter that is equipped with a gauge indicating when it needs to be replaced. Replace it if needed.

7.1.2 Annual Maintenance Schedule

Items on this list are required to be replaced with Certified OEM Spectrum Sports Intl replacement parts. Spectrum Sports Intl is not responsible for any product that has been altered or modified in any way, including the use of non-certified replacement parts. Failure to follow this annual replacement schedule may result in serious injury and or death for which Spectrum Sports Intl will not be liable.

- Replace all Auto-Bungee® cables.
- Check the axle bearings and grease as needed.

7.1.3 Maintaining Wear Items

The following components are wear items. It is up to the operator to monitor and determine when it is time for replacement based on the following guidelines. When in doubt, change it out!

- **Bungees:** Inspect for tears, excessive weather checking, or other damage.
- **Carabiners:** Replace if the auto-locking sleeve on the gate no longer snaps closed on its own. Surface rust, pitting, or wear grooves would also suggest the need for replacement.
- **Quick-Link:** Replace if the screw gate will no longer close. Surface rust, pitting, or wear grooves would also suggest the need for replacement. Tighten with tools and use Locktite® or tongue seal.
- **Pulleys:** Inspect the v-groove for wear and ensure that pulleys roll smoothly on bearings.
- **Auto-Bungee® Cylinders:** Replace when you see excessive oil leakage (visible on every stroke).
- **Lanyards:** Replace when you see fraying or stitching coming loose.

- **Guy Cables & Turnbuckles:** Replace if inspection parameters on page 30 reveal problems or if any surface rust or pitting appear. Guy cables must be used for safe operations!
- **Aluminum Poles:** Inspect for cracks, bends, or deformations.
- **Harnesses:** Inspect for fraying or undone stitches.

7.2 Service Options

The following service options are available:

- **On-Site Service:** Spectrum Sports Intl has offered the option of On-Site Service for over a decade. Our service truck travels the U.S. twice each year and is fully equipped. Service that aligns with the truck's schedule can be offered at a very competitive rate. The service offered may include cable replacement, parts replacement, inspection, and any other maintenance needs pertaining to the customers' request. To be added to the On-Site Service schedule, visit our website at www.spectrumsports.com to complete and submit the request form, or call (435) 792-3883.
- **Self-Installation:** Customers who wish to do their own maintenance have the option of ordering certified OEM parts directly from Spectrum Sports Intl. The customer then assumes all liability for the work, but the part is still covered by the manufacturer's warranty provided it is installed and used properly.
- **3rd Party Service:** Spectrum Sports Intl does not train, nor authorize, 3rd party vendors to service its products. If any 3rd party purports to be an authorized Spectrum Sports Intl servicer, please report it to us immediately.

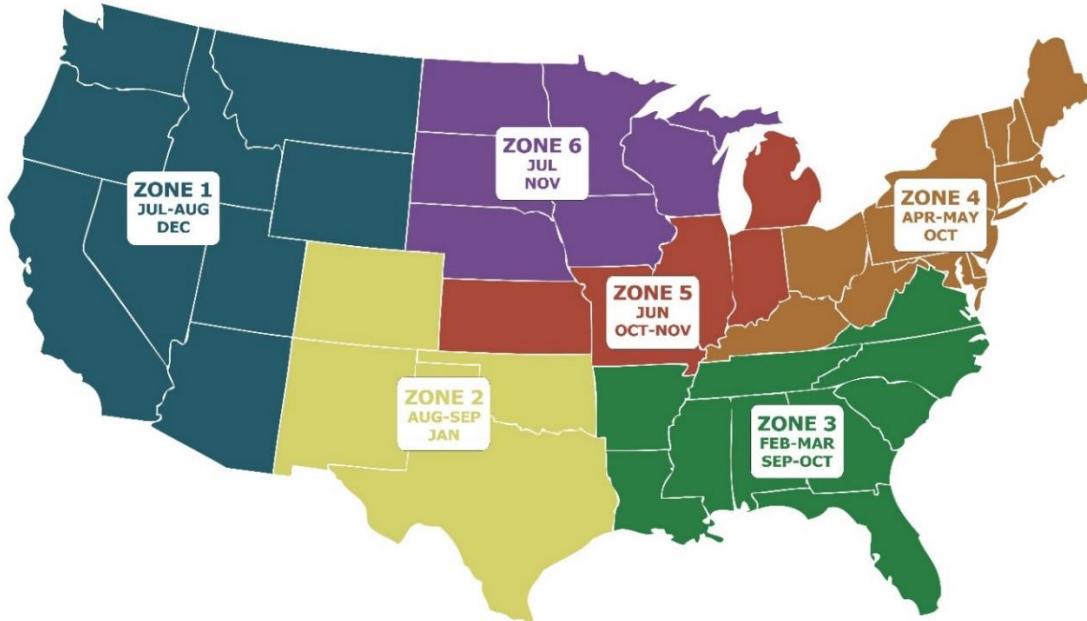

7.3 Cleaning

We recommend that you clean your Ultimate Bungee™ frequently. Use a spray nozzle and mild detergents and hand-dry thoroughly before storing.

We recommend using a furniture polish without natural oils to help keep steel parts clean and polished. This type of product leaves a light layer of wax on the steel to protect it and refreshes the finish. This process also provides an opportunity to look at the welds and inspect the product.



Attention!

Use caution if you use a pressure washer to clean. DO NOT point the nozzle directly at the Auto-Bungee®, lift pump, pivot points, grease points, electrical switches, or powder coat paint finish. You may damage the product.

Do not use any mineral spirits, acids, or other harmful chemical products on your Ultimate Bungee™.

7.4 Product Storage (Winterization)

If your Ultimate Bungee™ will not be in service for a period of 30 days or more, we recommend the following storage procedures.

- Disconnect battery cables from the battery (disconnect ground cable first). Store the battery indoors and off of the ground.
- Clean and properly store the inflatable jump pods. Make sure they are dry.
- Keep all safety gear in a dry location.
- If possible store entire product under roof or tarp.

If you have any questions or concerns, please call Spectrum Sports Intl at (435) 792-3883, or email us at service@spectrumsports.com.

8. WARRANTY

The warranty set forth below represents the manufacturer's sole warranty and is in lieu of any other expressed or implied warranties or obligations of Spectrum Sports Intl, its distributors, resellers/retailers, or employees. This warranty is null and void if other than genuine parts are used, or if any modifications are made without the express written permission of the manufacturer. This warranty only applies to the original purchaser, and is contingent upon the owner/operator using and maintaining the product in accordance with this manual.

Limited Product Warranty

The Ultimate Bungee™ by Spectrum Sports Intl is warrantied free from defect in material and workmanship for a period of 90 days from the date of purchase.

Additionally, the steel trailer and frame are warrantied for one year on welds and structure (does not include powder coat or any frame damage due to improper setup or damage due to misuse).

Equipment not manufactured by Spectrum Sports Intl (harnesses, lanyards, pulleys, etc.) is covered to the extent of the warranty provided by the original manufacturer.

Limitation of Remedy

Spectrum Sports Intl reserves the right to determine if a product is under warranty. Spectrum Sports Intl may elect at their discretion to use fabricators, distributors, and/or service agents local to customer to determine cause and/or repair of the particular part.

Spectrum Sports Intl's sole obligation under this warranty shall be to repair or replace any part or parts which, to their satisfaction, prove to be defective upon inspection. This obligation does not include labor to install replacement parts.

All claims in regards to the parts or equipment must be made within the warranty period.

To obtain repair or replacement parts, call **(435) 792-3883** or email **service@spectrumsports.com** for a **return authorization number**. Include the following information:

- Company name
- Contact name
- Office phone and/or mobile phone
- Ship-to address
- Date of purchase
- Product model
- Serial number

At your expense, ship or deliver the product or part to:

Spectrum Sports Intl
3785 North Highway 91
Hyde Park, Utah 84318

Replaced or repaired items will be shipped back to you at no cost and will be shipped in the same manner as they were received (i.e. overnight, 2nd day, ground, LTL freight, etc.).

For replacement parts that must be shipped to the customer before the original part is received back by Spectrum Sports Intl, it is REQUIRED that a valid credit card be charged for the replacement part before Spectrum Sports Intl will ship. Once Spectrum Sports Intl receives the original part, and if it deems that it is covered by warranty, a credit will be issued back to the credit card.

Spectrum Sports Intl is in no way responsible for lost revenue or income while product is not in operation due to warranty or any other problems due to installation and/or operations.

Warranty is only extended to the original owner.

Wear parts are not included under this warranty.

Should it be determined that the defect is due to abuse or misuse, any and all warranty rights or responsibilities are void.

If purchaser defaults in making payment for any parts or equipment, this warranty shall be void and shall not apply to such parts and equipment. No late payment or cure of default in payment shall extend the warranty period provided herein.

The warranty on Spectrum Sports Intl equipment remains valid only when genuine OEM Spectrum Sports Intl replacement parts are employed. Spectrum Sports Intl reserves the right to void warranty on any customer-modified parts. Furthermore, the customer will indemnify and hold Spectrum Sports Intl harmless from any damage or injury caused, including damage to the reputation, name, and good will of Spectrum Sports Intl.

If anyone other than a Spectrum Sports Intl authorized service technicians perform work or modify/repair any part of the product, it will VOID any warranty claim and will indemnify Spectrum Sports Intl from any liability.

The following items are considered to be the responsibility of the customer, and therefore, are not included under the terms of the warranty:

- Normal maintenance/routine service.
- Normal placement of service terms.
- Replacements required because of abuse, misuse, or incorrect operation of equipment by the installer or operator.
- Normal deterioration due to use and exposure.
- Strict adherence to this manual and the instructions herein or those provided by Spectrum Sports Intl and its service technicians is also a condition of warranty.

THIS WARRANTY IS EXPRESSLY IN LIEU OF OTHER WARRANTIES, EXPRESS OR IMPLIED, AND ANY IMPLIED WARRANTY OF MERCHANTABILITY OR FITNESS FOR A PARTICULAR PURPOSE IS HEREBY EXPRESSLY EXCLUDED.

Waiver & Release from Liability

NOTICE: BY ACCEPTING YOUR _____, YOU ARE ACKNOWLEDGING THAT YOU HAVE READ, UNDERSTOOD AND ACCEPTED THE TERMS AND CONDITIONS STATED IN THIS MANUAL. YOU FURTHER ACKNOWLEDGE AND AGREE THAT YOU ARE WAIVING YOUR RIGHTS TO SUE OR BRING A COURT ACTION TO RECOVER COMPENSATION OR OBTAIN ANY OTHER REMEDY FOR ANY INJURY TO YOURSELF OR YOUR PROPERTY.

This Release, Waiver and Assumption of Risk (“Agreement”) entered into by and between the owner/operator, on behalf of his/her/its heirs, legal representatives, personal representatives, attorneys, affiliates, administrators, successors and assigns (“Releasor”) and in favor of KBG International, Inc. a Utah corporation doing business as Spectrum Sports Intl, its past, present and future officers, directors, stockholders, attorneys, agents, servants, representatives, employees, subsidiaries, affiliates, partners, insurers, predecessors and successors in interest, indemnitors, assigns and other related or affiliated entities or persons (“Releasee”), desires to operate a _____ and any other recreational activities associated therewith (the “Activities”). In consideration for Spectrum Sports Intl providing maintenance or service to my equipment or permitting me to purchase and/or otherwise operate and engage in these Activities, I have agreed to execute this Acknowledgment, Waiver & Release and further, more particularly, agree as follows:

ACKNOWLEDGEMENT: I acknowledge and am thoroughly aware that there are significant inherent risks and hazards associated with the Activities and all other outdoor recreational activities or being a spectator of these Activities. **I FULLY ACKNOWLEDGE AND UNDERSTAND THAT PARTICIPATION IN THESE ACTIVITIES CONTAINS INHERENT RISKS THAT MAY BE UNKNOWN OR UNANTICIPATED THAT MAY RESULT IN PHYSICAL OR EMOTIONAL INJURY INCLUDING BUT NOT LIMITED TO PARALYSIS, PERMANENT INJURY OR DEATH AND DAMAGE TO PROPERTY OR TO OTHER THIRD PARTIES.**

I further acknowledge that the nature and extent of the risks and hazards inherent in the Activities and my pursuit of these activities include or operating equipment associated with the Activities, but are not limited to:

1. Severe bodily injury or death resulting from the Activities and equipment utilized in connection with the Activities;
2. Severe bodily injury or death resulting from equipment failure and/or malfunction of my own or others’ equipment, including, but not limited to, failures of ropes, slings, climbing harnesses, bolts, bolt hangers, fixed anchor points;
3. Severe bodily injury or death resulting from falling climbers/participants or falling or dropped items, including, but not limited to, ropes, climbing hardware or other debris;
4. Severe bodily injury or death from improperly placed or faulty climbing protection, improperly tied knots, improperly buckled harnesses, or improper rope/cable, belay, rope/cable ascending or rope/cable descending techniques;
5. Severe bodily injury or death resulting from operator or participants own negligence or the negligence of others including other climbers, operators, participants, spectators or users;
6. Severe bodily injury or death resulting from personal physical and mental limitations, including, but not limited to, fatigue, chill and/or dizziness, personal strength, coordination, sense of balance, which may diminish reaction time and increase risks of accident and ability to follow or give directions while climbing, lifting, spotting or being a spectator;
7. Severe bodily injury or death resulting from hazardous terrain or adverse weather conditions, including wind, rain, snow, hail or sleet;
8. Severe bodily injury or death resulting from not following proper and customary personal safety procedures including procedures outlined in the owner’s manual for the equipment

9. Severe bodily injury or death resulting from not having qualified personnel maintain or service the equipment and/or not properly inspecting the equipment in accordance with the owner's manual.

I acknowledge that the above list of severe bodily injuries, dangers, hazards, and risks are described by way of example only, and are not inclusive of all possible risks associated with the Activities, and that other unknown and unanticipated risks may result in bodily injury, illness or death. **I VOLUNTARILY ASSUME ALL SUCH RISKS WITH FULL KNOWLEDGE AND APPRECIATION OF THE DANGERS AND RISKS INVOLVED.**

RELEASE ASSUMPTION OF RISK AND RESPONSIBILITY: In consideration of my being allowed to participate and operate the equipment to conduct the Activities, and in recognition of the inherent risks of the Activities, I knowingly and intentionally agree on behalf of myself, my/our heirs, representatives, successors, officers, directors, stockholders, employees, executors, administrators, assigns, and anyone claiming interest through me, or on my behalf hereby **KNOWINGLY, INTENTIONALLY, AND VOLUNTARILY, RELEASE, WAIVE, DISCHARGE, HOLD HARMLESS AND AGREE NOT TO SUE** Releasees in or from any and all actions, suits, claims damages and liability (**INCLUDING ATTORNEY FEES OR COSTS**) or demands, obligations and/or causes of action of any nature whatsoever which I/we or, my heirs, representatives, successors, officers, directors, stockholders, employees, executors, customers, participants, administrators, assigns, and anyone claiming interest through me or my customers/participants may have against Releasees on account of any personal injury, property damage, death or accident of any kind arising out of or in any way connected with my operation of any equipment or anyone's participation in the Activities. I agree to indemnify and hold harmless Releasees from any and all liabilities or claims made by other individuals or entities as a result of my operation of or participation in the Activities. This release shall be effective even though said loss, damage, injury, paralysis, loss, or death results or has resulted from negligence, wrongful acts, omissions, breach of warranty or strict tort liability of Releasees (whether as the manufacturer or servicer of the equipment).

I further certify, acknowledge and agree on behalf of myself (or the company listed above) that I am physically and mentally capable of participating in these Activities;

I assume responsibility for and voluntarily assume the risks for any personal injury, death and related expenses involved with these Activities;

I assume responsibility for damage to my/our person or property or the person or property of participants in the Activities;

I agree to indemnify and hold harmless Releasees for any and all claims, as well as all fees and costs. I further agree to indemnify and hold harmless Releasees for any and all claims for products they did not manufacture, maintain or service.

I also understand that Spectrum Sports Intl is not responsible for claims or allegations regarding any product manufactured or produced by other parties or entities.

I certify that I have adequate insurance to cover any injury or damage I may cause or suffer while operating or participating, or else I agree to bear the costs of such injury or damage to myself or my customers. I further agree to name Spectrum Sports Intl as an additional insured party on my liability

insurance policy with limits of not less than \$1,000,000 per occurrence and \$2,000,000 in the aggregate.

Agreement & Acknowledgement

I have fully *read* the provided Operation and Owner's Manual and *understand* how to safely set up, inspect, operate, take-down, transport, maintain, and manage crowd and staffing issues for the Ultimate Bungee™ by Spectrum Sports Intl. I agree to operate only in accordance with these instructions and follow all of the warnings and cautions set forth in the manual.

I have carefully read the Limited Product Warranty, Limitation of Remedy, and Release of Liability and fully understand its contents. **I am aware that this is a release of liability and a contract** between me, Spectrum Sports Intl and its manufacturers, distributors, retailers, and employees.

If I do not understand the contents of this manual or warranty, or if I do not willfully accept the personal liability in the operation of the Ultimate Bungee™, I will immediately notify Spectrum Sports Intl in writing. I also acknowledge that I will not operate the said products until I do so.

APPENDICES

APPENDIX A. FORMS

Ultimate Bungee Parts Order Form

COMPANY:			SHIP TO:		
CONTACT:					
PHONE:			<input type="checkbox"/> Residential?		
EMAIL:			BILL TO:		
Payment: Credit Card / PO# / Warranty / Wire / Net 30					
Shipping: Ground / 2-Day / 3-Day / Overnight / DHL					
BUNGEEES, HARNESES, & RIGGING			AUTO-BUNGEE PARTS		
Item Description	Price	Qty	Item Description	Price	Qty
*Bungee Cords-Single Station Set	\$175.00		Auto-Bungee Cylinder 2"x24"	\$ 225.00	
*Bungee Cords-V4 Full Trailer Set	\$ 690.00		Moisture-Proof Breather Cap	\$ 6.00	
*Bungee Cords-V5 Full Trailer Set	\$ 862.00		Pressure Gauge	\$ 30.00	
Bungee Cord 10 lb	\$ 15.00		Oil Eye	\$ 10.00	
Bungee Cord 20 lb	\$ 15.00		Steel Cable (58' old BEC) White Board	\$ 125.00	
Bungee Cord 30 lb	\$ 17.00		Pulley, Plastic 6"	\$ 22.00	
Harness Child (Red)	\$ 200.00		Nylon Cable Rollers (pair)	\$ 10.00	
Harness Adult (Blue)	\$ 240.00		Pulley Cart Bearing	\$ 4.50	
Lanyard (12" looped)	\$ 25.00		2.5" Pulley Bolt	\$ 4.00	
Rigging Rope (each)	\$ 50.00		7" Pulley Bolt	\$ 9.00	
Single Alloy Pulley	\$ 30.00		Nylock Nut	\$ 2.00	
Double Alloy Pulley	\$ 65.00				
Carabineer (Steel Auto-Locking)	\$ 24.00		TRAILER PARTS		
Quicklink	\$ 6.00		Item Description	Price	Qty
Swivel	\$ 62.00		Swivel Jack	\$ 90.00	
MISC PARTS			Battery (12v Deep Cycle)	\$ 120.00	
Item Description	Price	Qty	Battery Box, Plastic w/ strap	\$ 25.00	
Rave Bongo	\$ 900.00		7-Pin Trailer Plug	\$ 39.00	
Bongo Blower	\$ 150.00		Trailer Plug Box	\$ 19.00	
Aluminum Jump Pole (Bare)	\$ 450.00		Coupler Pin	\$ 6.00	
Pole Pins (1/2" x 5") & R-clip	\$ 9.00		Coupler 2"	\$ 160.00	
Banner (1 of 4)	\$ 60.00		Coupler 2-5/16"	\$ 160.00	
3/8" X 1 5/8" spring clip pin	\$ 4.00		Hydraulic Lifting Cylinder	\$ 245.00	
Utility Pole	\$ 100.00		Hydraulic Lift Pump	\$ 900.00	
Utility Pole Storage Clip	\$ 8.00		Gas Shock for support arm	\$ 70.00	
Bungee Latch Spring	\$ 2.00		Start/Stop Button Complete	\$ 90.00	
Zerk Fitting	\$ 0.50		Key Switch	\$ 130.00	
Bungee Pole Latch Pin	\$ 90.00		Replacement Key (# on switch)	\$ 15.00	
Collar	\$ 30.00		Solenoid	\$ 50.00	
Bungee Pole Latch Pin w/ 2 collars	\$ 150.00				
Rules Sign	\$ 25.00				

*V4 Full Trailer Set (16 of each color)
 *V5 Full Trailer Set (20 of each color)

*Single Station Set (4 of each color)



Pulled By:	Spool #
Serial Numbers:	
Box Weight:	

Figure 32. Accessories & Parts Order Form

APPENDIX B. ACCIDENT REPORTING



Designation: F 1305 – 94

Standard Guide for the Classification of Amusement Ride and Device Related Injuries and Illnesses¹

This standard is issued under the fixed designation F 1305; the number immediately following the designation indicates the year of original adoption or, in the case of revision, the year of last revision. A number in parentheses indicates the year of last reapproval. A superscript epsilon (ϵ) indicates an editorial change since the last revision or reapproval.

1. Scope

1.1 This guide provides a uniform procedure that should be used when classifying patron injury and illness data related to amusement rides and devices.

1.2 *This standard does not purport to address all of the safety concerns, if any, associated with its use. It is the responsibility of the user of this standard to establish appropriate safety and health practices and determine the applicability of regulatory limitations prior to use.*

2. Terminology

2.1 *Definitions of Terms Specific to This Standard:*

2.1.1 *illness*—personal discomfort resulting in treatment including a personal illness, food poisoning, drug abuse, toxic inhalation, insect sting, or other similar occurrence.

2.1.2 *injury*—sustained bodily harm resulting in treatment such as trauma, cuts, bruises, burns, and sprains.

2.1.3 *minor injuries/illnesses*—injuries and illnesses which may or may not require emergency first aid or significant treatment, or both, but cannot be otherwise classified as a serious injury or illness. This category includes incidents where treatment is limited to such things as the dispensation of over-the-counter medication or plastic adhesive strips², cleansing, rest, and other similar duties or assistance.

2.1.4 *serious injuries/illnesses*—a personal injury/illness that results in death, dismemberment, significant disfigurement, permanent loss of the use of a body organ, member, function, or system, a compound fracture, or other significant injury/illness that requires immediate admission and overnight hospitalization and observation by a licensed physician.

3. Significance and Use

3.1 The purpose of this guide is to provide a uniform procedure under which the amusement ride and device industry can organize data related to injuries and illnesses. This classification system may be used to formulate statistical information within the categories provided and will facilitate the analysis of

injury and illness incidents. The classification system may assist owner/operators and manufacturers to review incidents directly related to their amusement rides and devices, and may provide information for alternatives to reduce or eliminate similar occurrences.

4. Recording Recommendations

4.1 The administration of emergency health care service and treatment should be recorded as deemed appropriate by the owner/operator of amusement rides and devices to include the documentation of all first-aid treatment, including minor injuries and illnesses, in a first-aid log. Injuries and illnesses other than minor should be reported on a firstaid incident report in accordance with 4.2.

4.2 *First-Aid Incident Report*—A first-aid incident report should be completed for injuries or illnesses that result in hospital admission or where medical treatment is given, recommended, or may be required at a future date. All injuries or illnesses reported and other than those classified as minor, can be presumed to be in this category.

4.3 *Recorded Information:*

4.3.1 Information recorded in the first-aid incident report should include but not be limited to the following, where applicable:

4.3.1.1 Date the incident occurred.

4.3.1.2 Name, address, and telephone number of the person to receive emergency health care service or treatment.

4.3.1.3 Age of the person to receive emergency health care service or treatment.

4.3.1.4 Manufacturer's name of the amusement ride or device where or on which the incident occurred.

4.3.1.5 Description of the injury or illness. Physical description of the injury or illness. Description of the events causing and related to the incident.

4.3.1.6 Description of the first-aid service or treatment administered including medications given.

4.3.1.7 Incident classification in accordance with Section 5.

4.3.1.8 Additional information deemed necessary by the owner/operator.

5. Classification of First-Aid Incidents

5.1 When recording an applicable first-aid-related incident the owner/operator of an amusement ride or device should classify the injury or illness in accordance with each of the

¹ This guide is under the jurisdiction of ASTM Committee F-24 on Amusement Rides and Devices and is the direct responsibility of Subcommittee F24.40 on Operations.

Current edition approved April 15, 1994. Published June 1994. Originally published as F 1305-90. Last previous edition F 1305-90.

² Band-Aid brand adhesive strips, a trademark of Johnson and Johnson Products, Inc., New Brunswick, NJ 08093, have been found suitable for this purpose.

 **F 1305**

following categories based on the available reported or observed reliable information, or both:

5.1.1 *Amusement Ride and Device Incidents Classified in Accordance with Injury Qualification and Degree of Injury*—Injury, illness, serious injury/illness, and minor injury/illness as defined in Section 2 should be determined by the owner/operator to best describe the incident circumstances.

5.1.2 *Amusement Ride and Device Incidents Classified in Accordance with Facility Implication*:

5.1.2.1 *Facility-Related Incidents*—Injuries or illnesses that occur on facility premises shall be additionally classified as “Facility Related.”

5.1.2.2 *Not-Facility Related Incidents*—Injuries or illnesses that occur off facility premises shall be additionally classified as “Not Facility Related.”

5.1.3 *Amusement Ride and Device Incidents Classified in Accordance with Facility Location*:

5.1.3.1 *Amusement Ride and Device on Ride Incident*—Injuries or illnesses that actually occur to a person while riding during the operation of the amusement ride or device, including during the start up or shut down procedures, shall be additionally classified as an amusement ride and device “On Ride Incident.”

5.1.3.2 *Loading and Unloading Incidents*—Injuries or illnesses that actually occur to a person while he is within the area designated for loading and unloading of an amusement ride or device that was under the direct control of an amusement ride and device operator or attendant shall be additionally classified as a “Loading and Unloading Incident.”

5.1.3.3 *Queue Line Incident*—Injuries or illnesses that actually occur to a person while in a queue line for an amusement ride or device shall be additionally classified as a “Queue Line Incident.”

5.1.3.4 *Other Incidents*—Injuries or illnesses that occur to a person in a location other than as described in 5.1.3.1, 5.1.3.2, or 5.1.3.3 shall be classified as other than the preceding classifications and should be categorized in accordance with other predetermined descriptions that may be established by the owner/operator.

6. Manufacturer Notification

6.1 The owner/operator of an amusement ride or device shall notify the appropriate manufacturer(s) of an incident that resulted in a serious injury as defined in 2.1.4 within seven days of the occurrence of the incident.

The American Society for Testing and Materials takes no position respecting the validity of any patent rights asserted in connection with any item mentioned in this standard. Users of this standard are expressly advised that determination of the validity of any such patent rights, and the risk of infringement of such rights, are entirely their own responsibility.

This standard is subject to revision at any time by the responsible technical committee and must be reviewed every five years and if not revised, either reapproved or withdrawn. Your comments are invited either for revision of this standard or for additional standards and should be addressed to ASTM Headquarters. Your comments will receive careful consideration at a meeting of the responsible technical committee, which you may attend. If you feel that your comments have not received a fair hearing you should make your views known to the ASTM Committee on Standards, 100 Barr Harbor Drive, West Conshohocken, PA 19428.

This standard is copyrighted by ASTM, 100 Barr Harbor Drive, West Conshohocken, PA 19428-2959, United States. Individual reprints (single or multiple copies) of this standard may be obtained by contacting ASTM at the above address or at 610-832-9685 (phone), 610-832-9655 (fax), or service@astm.org (e-mail); or through the ASTM website (<http://www.astm.org>).

APPENDIX C. WIRING

SCHEMATIC WIRING DIAGRAM FOR TEKONSHA 2010 BREAKAWAY SWITCH

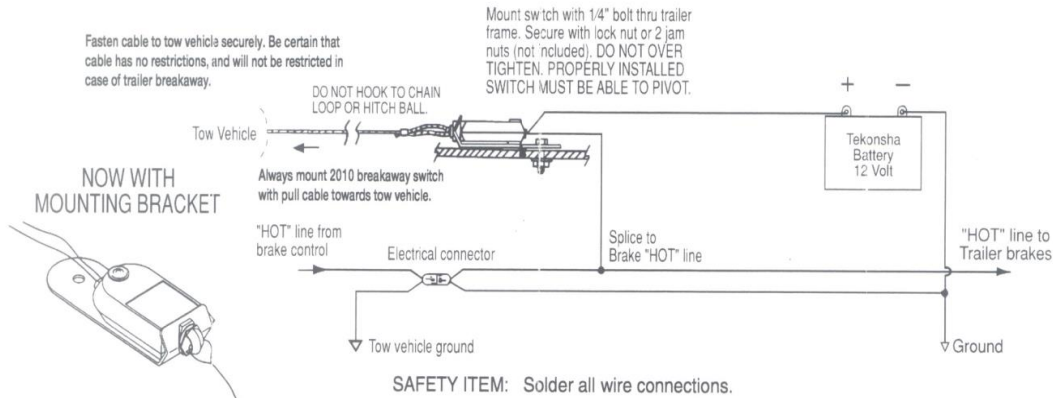

ATTENTION INSTALLER: Please give this sheet to consumer upon completion of installation.





















1. Mount Tekonsha battery case securely to frame, jack post or other suitable location on trailer.
2. Bolt breakaway switch bracket to frame of trailer or battery case bracket using 1/4" bolt and lock nut or (2) 1/4" jam nuts. (Bolt and nuts not included in kit).
 CAUTION: Do not overtighten bolt. Switch must be able to pivot.
3. Check and install battery.
4. Wire per schematic diagram. Properly insulate all connections.
5. Attaching to tow vehicle:
 Attach cable to tow vehicle frame being certain no strain is placed on cable.
 CAUTION: Do not hook cable to safety chain loop or hitch ball.
 CAUTION:
 1. Switch location should be selected to insure unobstructed line of pull in event of vehicle separation.
 2. Do not let cable drag on ground.
 3. Check condition of battery prior to each trip.
 4. **WARNING: Disconnect trailer plug before testing breakaway unit. Failure to do so will result in severe damage to electronic brake control.**



ENGINEERING COMPANY 537 N. CHURCH STREET, TEKONSHA, MICHIGAN 49092 Phone: (517) 767-4142

Rev. E 0698
p/n 538

Figure 33. Breakaway Switch Wiring Schematic

TAP™	6-WAY MOLDED CABLES			7-WAY MOLDED CABLES		
	Function	Gauge	Location*	Function	Gauge	Location*
 yellow	Left Turn / Brake	14		Auxiliary Power	14	
 green	Right Turn / Brake	14		Tail / Marker Light	14	
 brown	Tail / Marker Light	14		Right Turn / Brake	14	
 white	Ground	14		Ground	10	
 black	Auxiliary Power	14		Battery	10	
 red	Electric Brakes	14		Left Turn & Brake	14	
 blue				Electric Brakes	12	

*Locations are given looking at the FRONT of the plug.



Figure 34. TAP Molded Cables (Wiring)

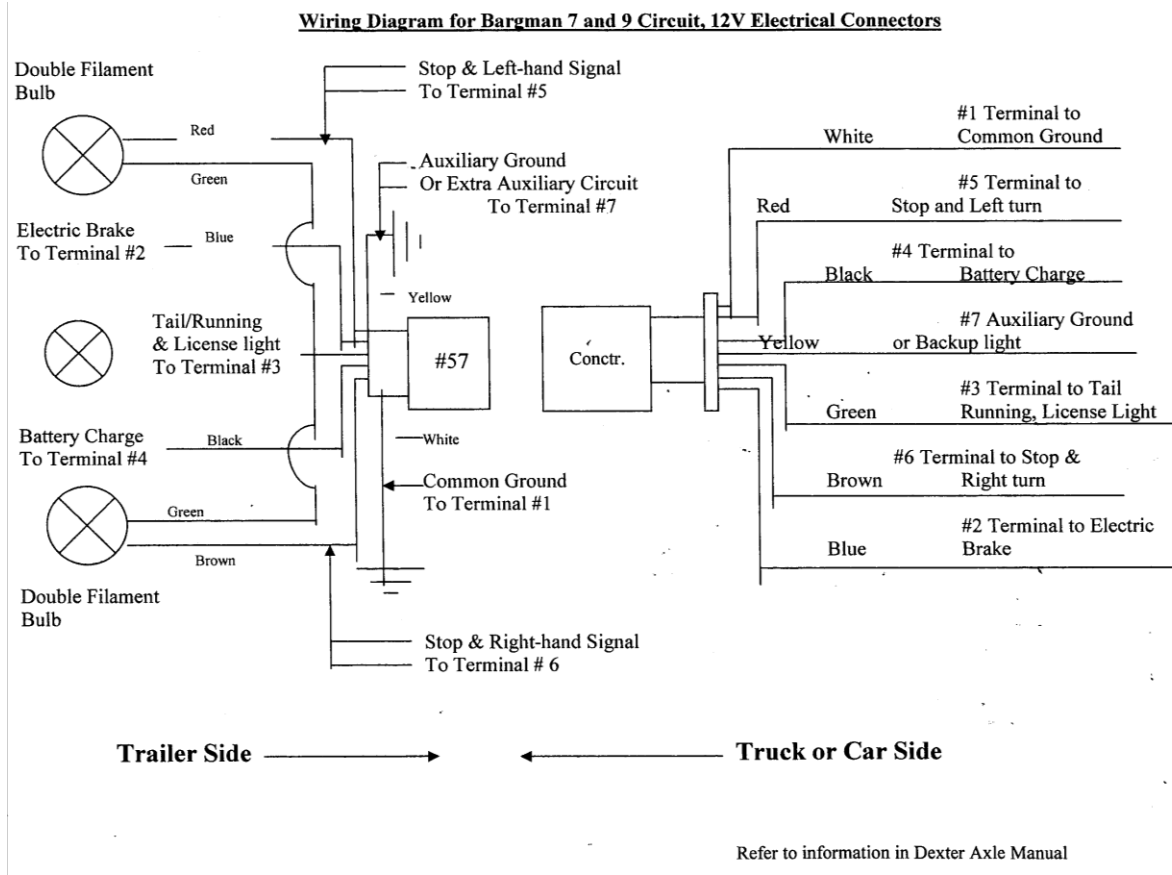

Figure 35. Wiring Diagram for Bargman 7 and 9 Circuit (12V Electrical Connectors)