

SPECTRUM

SPORTS INTL

STATIONARY CLIMBING TOWER OWNER/OPERATOR'S MANUAL



Attention!

***IMPORTANT SAFETY INFORMATION INSIDE. READ THIS
MANUAL BEFORE SETTING UP AND OPERATING THE
STATIONARY CLIMBING TOWER.***

Change of Owner/Operator Form

Original Owner:

Company Name: _____

Contact name(s): _____

Bill to Address: _____

City: _____ State: _____ Zip: _____

Phone: _____ Alt. Phone: _____ Fax: _____

Former Location: _____

City: _____ State: _____ Zip: _____

Date Sold: _____

New Owner/Operator Information:

Company Name: _____

Contact name(s): _____

Bill to Address: _____

City: _____ State: _____ Zip: _____

Phone: _____ Alt. Phone: _____ Fax: _____

Current Location: _____

City: _____ State: _____ Zip: _____

Product Information:

GAR, DAR, CND, RL, CTC, CNC

Mobile/Stationary 20' 22' 24' 28' 30' 32' Custom: _____

Serial # _____

VIN # _____

Year: _____

*Please mail or fax to:
324 W 2500 N Bldg A
North Logan, UT 84341
Fax: (435) 792-3884

TABLE OF CONTENTS

Stationary Climbing Tower i

Owner/Operator’s Manual i

Change of Owner/Operator Form..... ii

LIST OF TABLES v

LIST OF FIGURES..... v

1. Introduction 1

1.1 Receipt & Acknowledgment2

1.2 Manual Overview2

 1.2.1 Revisions 3

 1.2.2 Warning Signs..... 3

1.3 Product Overview4

 1.3.1 Product Identification 5

1.4 Accident Reporting5

1.5 Engineering Approval.....6

2. The Auto-Belay Safety System..... 7

2.1 Certifications / Standards.....7

 2.1.1 ASTM Requirements for Owner/Operator Responsibilities 7

2.2 Product Specs8

 2.2.1 Height Limits 8

 2.2.3 AB32 Specs (Generation 4) 8

 2.2.4 AB40 Specs (Generation 4) 9

 2.2.5 AB75 Specs (Generation 4) 10

 2.2.6 AB32 Specs (Generation 5) 10

 2.2.7 AB40 Specs (Generation 5) 11

 2.2.8 AB75 Specs (Generation 5) 12

2.3 Auto-Belay Sticker Package (Gen 3, 4, & 4.5)13

2.4 Auto-Belay Sticker Package (Gen 5)14

3. Inspections 15

3.1 Priming the Auto-Belay15

3.2 Inspecting Wear Items16

3.3 Checking Air Pressure17

3.4 Inspecting the Hydraulic Fluids.....17

3.5 Cable Inspections.....17

 3.5.1 Replacing the Cable..... 18

 3.5.2 Cable Replacement Options..... 19

 3.5.3 Wire Rope Inspection Comparison 20

3.6 Daily Inspections22

3.7 Weekly Inspections.....22

3.8 3-Month Inspections.....22

3.9 12-Month Inspections	22
3.10 Inspection Checklists.....	23
3.10.1 Quick Reference Checklist.....	23
3.10.2 Daily Inspection Checklist	24
3.10.3 Weekly Inspection Checklist	25
3.10.4 3 Month Inspection Checklist	26
3.10.5 12 Month Inspection Checklist	27
3.11 Stationary Climbing Wall Inspections.....	28
3.11.1 Non-Destructive Examination (NDE) Inspection Policy	29
4. Prep the Auto-Belay	30
4.1 Priming of the Auto-Belay.....	30
5. Operating the Auto-Belay	31
6. Climbing Operations	32
6.1 Required Personnel for Operations	32
6.1.1 Climb Master Duties.....	32
6.1.2 Assistant Duties.....	33
6.2 Climbing Zones	33
6.3 Rules and Safety Tips	35
6.4 Emergency Climber Recovery	35
7. Maintenance	36
7.1 Maintenance & Service	36
7.2 Service Options.....	36
7.3 Cleaning	37
7.4 Product Storage (Winterization).....	38
8. Warranty	39
8.1 Warranties and Liabilities.....	39
8.2 Conclusion.....	45
8.3 Entertainment Tips	45
9. Troubleshooting	46
Appendices	48
Appendix A. Forms	49
Appendix B. Changing an Auto-Belay Cylinder.....	51
Appendix C. Oil Collection Kit Installation	52
Appendix D. Seal Kit Replacement	53
Appendix E. Cable Replacement (Both Ends Terminated)	55
Appendix F. Wiring.....	58
Appendix G. ASTM F 1305.....	60
Appendix H. Climbing Tower Horn Diagram	62
Appendix I. Spectrum Sports Intl Quick-Harness.....	63

LIST OF TABLES

Table 1. Warning Signs..... 3
Table 2. Spectrum Sports Intl Products..... 4

LIST OF FIGURES

Figure 1. Auto-Belay Sticker Package (Gen 3, 4, & 4.5)..... 13
Figure 2. Single Wire Inspection Criteria for the Auto-Belay Wire Ropes..... 18
Figure 3. Coconut Tree Climbing Safety Zone..... 34
Figure 4. DROP-A-ROCK Climbing Safety Zone 34

1. INTRODUCTION

Thank you for purchasing a quality-built climbing product from Spectrum Sports Intl. We take pride in our products and believe that we build the best products in our industry. Our philosophy is centered on a commitment of excellence in meeting the needs of our customers and providing quality products that are safe, exciting, and profitable. We encourage you to likewise develop a standard of quality and service.

What makes our team successful is:

- ✓ Commitment to a proper, effective, and profitable design.
- ✓ Third Party Engineering on all our products.
- ✓ Manufacturing our products according to the “ASTM F-24” amusement industry safety standards.
- ✓ Testing designs before they are put into use and sold.
- ✓ Maximum customer through-put, generating high profits.
- ✓ Building quality products, which means the ownership costs are lower.
- ✓ Experience and leadership in the industry.
- ✓ In-house assembly on all of our products (this provides for exceptional Quality Control).

Your part in building a successful business using Spectrum Sports Intl products is to:

- Have a commitment to safe operation.
- Have consistent inspections for needed maintenance.
- Effectively and actively market and promote the product.
- Use Spectrum Sports Intl certified replacement parts.



Attention!

Always remember to follow all safety guidelines and use caution while operating your product.

Spectrum Sports Intl is a company that has designed the following products: Climb-N-Dangle®, Drop-A-Rock®, Grip-A-Rock®, RidgeLine®, Climb-N-Challenge®, Klime Wallz®, and Coconut Tree Climb®. This manual will be used to document the operating procedures and safety warnings associated with the Stationary Climbing Tower®.



Attention!

The guidelines in this manual must be read and understood by all Stationary Climbing Tower personnel.

Copyright© Spectrum Sports Intl

Reproduction or translation of any part of this work beyond that permitted by Section 107 or 108 of the 1976 United States Copyright Act without permission of the copyright owner is unlawful. Requests for permission or further information should be addressed to Spectrum Sports Intl.

1.1 Receipt & Acknowledgment

This owner/operator's manual is an important document intended to help you become acquainted with the Climbing Towers and the Auto-Belay Safety Systems.



Attention!

Please read the following statement and contact Spectrum Sports Intl, in writing, if the intent of this document is unclear or questions arise. YOU SHOULD NOT OPERATE THE PRODUCTS MENTIONED IN THIS MANUAL IF YOU DO NOT FULLY UNDERSTAND HOW TO OPERATE THEM SAFELY!

“As an owner, I have received, and read, my copy of the Climbing Tower Owner's Manual. I understand that the information outlined in this manual is subject to change at the sole discretion of Spectrum Sports Intl at any time. It is further understood that as an owner of the Climbing Tower, I have the responsibility to ensure that the correct and latest version of the manual is being used.

As an owner of the Climbing Tower or authorized representative, it is my responsibility to keep this manual up to date with any changes that are made by Spectrum Sports Intl. In addition, if there is anything about the product and/or this manual that is unclear or not understood, it is my responsibility to seek clarification and not use the product until the issue is understood.

Unless informed in writing, Spectrum Sports Intl assumes that the customer understands the Climbing Tower product and that there are no questions regarding the product and/or the contents of this document, use of the product, or how to operate this product.”

It is the sole responsibility of the customer to clarify any question or concern with Spectrum Sports Intl before use and/or operation.

1.2 Manual Overview

This manual is an introduction to the climbing tower and its operation. The purpose of this manual is to provide a compilation of information that will assist you in proper and safe operation.

The philosophy of Spectrum Sports Intl is centered on a commitment to excellence in meeting the needs of its customers and associates by providing them with the enclosed information.

This manual is designed to provide the product owner with the information, tips, and techniques that will help the owner and employees operate the Climbing Tower as effectively and safely as possible. This manual is in no way a total representation of all facts related to the product or equipment. Safe operation of this product is the sole responsibility of the wall owner/operator. Good and reasonable judgment must be used when traveling, promoting and/or operating the product.

1.2.1 Revisions

Spectrum Sports Intl may make periodic additions, deletions, and modifications to this manual. These updates will, in the judgment of Spectrum Sports Intl, add to the quality of services offered. This manual must be kept up to date and should reflect all updates currently in use.





Attention!

Please check the following websites for updates and/or safety issues regarding your Climbing Tower & Auto-Belay Safety System: www.spectrumsports.com or www.auto-belay.com.

1.2.2 Warning Signs

The following warning signs will appear throughout this manual:

Table 1. Warning Signs

SYMBOL	WARNING NAME	DESCRIPTION
	Attention	This icon and font will be used to draw attention to important tips or setup procedures.
	Warning	This icon, and font, will be used to draw attention to important safety warnings.



Attention!

Spectrum Sports Intl will not warranty or stand behind any Stationary Climbing Tower and/or Auto-Belay Safety System that we have manufactured that does not use genuine and/or authorized replacement parts and/or cables. Any work and/or services that are performed on any Spectrum Sports Intl Auto-Belay Safety Systems that are not performed by an authorized Spectrum Sports Intl employee, voids any and all claims to any manufacturer's liability.

Read and understand this manual before installing and/or operating the product.



Warning!

Climbing and/or failing to comply with the information in this manual may result in serious injury or death.

1.3 Product Overview

Welcome to Spectrum Sports Intl Stationary Climbing Tower products. As the originators and inventors of the Auto-Belay Safety System and the products mentioned in this manual, Spectrum Sports Intl products are industry leaders in innovation, safety, design, and customer satisfaction. Spectrum Sports Intl designs their products for the amusement, entertainment, climbing, and recreation industries. Because of this, the products are engineered with safety, customer appeal, and customer through-put in mind. All of our Climbing Tower products are designed to meet ASTM F-24 standards. All products have an Engineering Certified stamp from 3rd party Engineering firms.

The following products are covered in this manual. Please take note of the abbreviated terms for each product. If you have any questions on what product you have, call Spectrum Sports Intl with your serial number and we will identify your product.

Table 2. Spectrum Sports Intl Products

PRODUCT NAME	TYPE	ABRV.
Climb-N-Dangle®	Wall	CND
Drop-A-Rock®	Wall	DAR
Grip-A-Rock®	Wall	GAR
RidgeLine®	Wall	RL
Climb-N-Challenge®	Vertical Rope Course	CNC
Coconut Tree Climb®	Tree	CTC

We use the best quality of materials in all our Climbing Towers. From the fiberglass climbing wall surfaces to our Coconut Tree Climb trees, to the steel quality and steel thickness. You get more for your money when you buy a Spectrum Sports Intl product.

All our Products come with the Auto-Belay Safety System. Be sure to completely read and understand how the Auto-Belay Safety System operates. This is the key part of your product having safe operation, and your business being successful.

1.3.1 Product Identification

Product Name: _____

Model: _____ Date Manufactured: _____

Specialty Items: _____

Serial Number: _____

Passenger Capacity: ____ Number of Auto-Belay Safety Systems: _____

Company Name: _____

Customer Name: _____

Phone Number: _____

Address: _____

1.4 Accident Reporting

Spectrum Sports Intl requires that any and all accidents are reported within 48 hours from the time of the accident. We need the following information:

- Name of the injured.
- Place of the accident.
- An incident report.
- The route the accident occurred on.
- A description of the accident.
- A description of the proposed product failure.
- The employee's name.
- Daily inspection report/checklist.
- Date the employee was trained on the use of the product.

More info may be required at a later time. Email or fax a report to: sales@spectrumsports.com or 435-792-3884.

1.5 Engineering Approval

Our products have been designed and reviewed by 3rd party engineers that stand behind the product design. If it is necessary that you receive a copy of the engineering analysis, Spectrum Sports Intl will provide a copy contingent upon the signing of a “non-disclosure/non-compete agreement” and a small fee.

Please call Spectrum Sports Intl for details.



Attention!

The customer is responsible for finding what current codes are required to operate each Spectrum Sports Intl product within their state.

2. THE AUTO-BELAY SAFETY SYSTEM

This manual is an introduction to the Auto-Belay Safety System and its operation. The purpose of this manual is to provide a compilation of information that will assist you in proper and safe operation. This manual is designed to aid in educating you and your associates.

“Belaying” is a climbing term that describes the process of taking up slack in a climber’s safety line as they ascend, and then safely lowering the climber when they either fall or wish to descend. This process is managed by a “Belay Partner” in traditional rock climbing. The term “Auto-Belay” is used to describe a device that replaces the “Belay Partner” with a mechanical apparatus.

The Spectrum Sports Intl Auto-Belay Safety System is an air/oil hydraulic apparatus. As a climber ascends, air pressure works upon the device in a manner that collects any slack in the climber’s safety line. When the climber descends, oil flow through the device is restricted in a manner that safely slows the rate of descent. Four generations of design evolution, 3rd party engineering, and millions of safe cycles worldwide have proven that the Spectrum Sport Intl Auto-Belay is the safest and most reliable on the market.



Attention!

All Spectrum Sports Intl Climbing Tower products will come with the Auto-Belay Safety Systems. Be sure that you are completely familiar with the safety and operation guidelines before you use this Auto-Belay Safety System.

2.1 Certifications / Standards

Spectrum Sports Intl has the following certifications and meets/exceeds the following industry standards:



2.1.1 ASTM Requirements for Owner/Operator Responsibilities

“Owner/operators of amusement rides or devices shall have an inspection program consistent with the inspections outlined in Practice F 853 & Practice F 770. Inspection documents deemed appropriate by the owner/operator to be maintained in the ride file shall be filed in accordance with the procedures

outlined in Practice F 770 and Practice F 853. The owner/operator of an amusement ride or device shall promptly notify the manufacturer of an incident, failure, or malfunction which, in his judgment, seriously affects the continued proper operation of the ride or device and is information of which the manufacturer should be aware.”

(Ref: ASTM International Standards on Amusement Rides and Devices: 7th Edition, Sections: 5.2.1-5.2.3)

2.2 Product Specs

2.2.1 Height Limits

The height limits for the Auto-Belay Safety Systems AB32, AB40, and AB75 products are listed in the table below.

Table 3. Auto-Belay Safety System Height Limits

PRODUCT	0'- 32'	0'- 40'	0'- 75'
AB32			
AB40			
AB75			

(For Generations 3, 4, 4.5, and 5)

2.2.3 AB32 Specs (Generation 4)

The following specifications are associated with a 4th generation AB32:

- **Size:** 9'3" (2.81M) long, 12" (304.8mm) wide, and 17" (431.8mm) deep
- **Weight:** 180 lbs. (81.64 kg)
- **Mounting Height:** Typically ground level, remote location okay
- **Climbing Range:** 0'-32' (9.75M)
- **Maximum climbers' weight:** 250 lbs. (113.39 kg)
- **Color:** Black powder coated finish
- **Design:** Dual cylinder-open design
- **Body Material:** Steel
- **Cylinders:** 39" X 1 ½" 2500 PSI (Qty 2)
- Weatherproof hydraulic breather caps (Qty2)
- **Pulleys:** 6" sealed bearing, nylon (Qty 9) for ¼" cable
- **Oil:** ISO 32
- **Upper Pulley Cart:** 8 sealed bearing

• Air Pressure:	
Gen 3, 4, & 4.5	Gen 5
85-95 PSI	95-100PSI

- **Hoses:** 2000 PSI (137.89 bar)
- **Fittings:** #10, O-ring with face seals
- **Hardware:** Grade 8 on pulleys, grade 5 on assemblies
- **Oil Filtration System:** Yes, inline screen
- **Oil Containment System:** Available at an additional cost
- **Oil Site Glass:** Mounted for clear inspections
- **Pressure Gauge:** 0- 150 PSI (10.34 bar)
- **Breather Cap:** Low profile
- **1" quick connections pins:** On both Auto-Belay cylinders
- Easy 4 bolt mounting system

2.2.4 AB40 Specs (Generation 4)

The following specifications are associated with a 4th generation AB40:

- **Size:** 9'3" long, 14" wide, and 17" deep
- **Weight:** 180 lbs.
- **Mounting Height:** Typically ground level, remote location okay
- **Climbing Range:** 10'-40'
- **Maximum climbers' weight:** 250 lbs. (113.39 kg)
- **Color:** Black powder coated finish
- **Design:** Dual cylinder-open design
- **Body Material:** Steel
- **Cylinders:** 39" X 1 ½" 2500 PSI (Qty 2)
- Weatherproof hydraulic breather caps (Qty2)
- **Pulleys:** 6" sealed bearing, nylon (Qty 9) for a ¼" cable
- **Oil:** ISO 32
- **Upper Pulley Cart:** 8 sealed bearing
- **Air Pressure:** 95 – 105 PSI operations pressure
- **Hoses:** 2000 PSI
- **Fittings:** #10, O-ring with face seals
- **Hardware:** Grade 8 on pulleys, grade 5 on assemblies
- **Oil Filtration System:** Yes, inline screen
- **Oil Containment System:** Available at an additional cost
- **Oil Site Glass:** Mounted for clear inspections
- **Pressure Gauge:** 0- 150 PSI
- **Breather Cap:** Low profile
- **1" quick connections pins:** On both Auto-Belay cylinders
- Easy 4 bolt mounting system

2.2.5 AB75 Specs (Generation 4)

The following specifications are associated with a 4th generation AB75:

- **Size:** 9'3" long, 24" wide, and 17" deep
- **Weight:** 370 lbs.
- **Mounting Height:** ground level, remote location okay
- **Climbing Range:** 10' - 75'
- **Maximum climbers' weight:** 250 lbs.
- **Color:** Black powder coated finish
- **Design:** Dual cylinder-open design
- **Body Material:** Steel
- **Cylinders:** 39" X 1 ½" 2500 PSI (Qty 2)
- **Pulleys:** 6" sealed bearing, nylon, fits 10.5 mm rope (Qty 9)
- **Oil:** ISO 32 w/blue dye
- **Upper Pulley Cart:** 8 sealed bearing
- **Air Pressure:** 105 – 110 PSI operations pressure (depends on routing)
- **Hoses:** 2000 PSI
- **Fittings:** #10, O-ring with face seals
- **Hardware:** Grade 8 on pulleys, grade 5 on assemblies
- **Oil Filtration System:** Yes, inline screen
- **Oil Containment System:** Available at an additional cost
- **Oil Site Glass:** mounted for clear inspections
- **Pressure Gauge:** 0- 160 PSI
- **Breather Cap:** Low profile
- **1" quick connections pins:** On both Auto-Belay cylinders
- Easy 4 bolt mounting system

2.2.6 AB32 Specs (Generation 5)

The following specifications are associated with a 4th generation AB32:

- **Size:** 9'3" (2.81M) long, 12" (304.8mm) wide, and 17" (431.8mm) deep
- **Weight:** 214 lbs. (97 kg)
- **Mounting Height:** Typically ground level, remote location okay
- **Climbing Range:** 0' - 32' (9.75M)
- **Maximum climbers' weight:** 250 lbs. (113.39 bar)
- **Color:** Black powder coated finish
- **Design:** Dual cylinder-open design
- **Body Material:** Steel
- **Cylinders:** 39" X 2" 2500 PSI (Qty 2)
- Weatherproof hydraulic breather caps (Qty2)
- **Pulleys:** 6" sealed bearing, nylon (Qty 9) for ¼" cable

- **Oil:** ISO 32
- **Upper Pulley Cart:** 8 sealed bearing
- **Air Pressure:** (Gen. 3, 4, and 4.5) 85 – 95 PSI (5.8-6.5 bar) operations pressure
- **Hoses:** 2000 PSI (137.89 bar)
- **Fittings:** #10, O-ring with face seals
- **Hardware:** Grade 8 on pulleys, grade 5 on assemblies
- **Oil Filtration System:** Yes, inline screen
- **Oil Site Glass:** Mounted for clear inspections
- **Pressure Gauge:** 0- 150 PSI (10.34 bar)
- **Breather Cap:** Low profile
- **1" quick connections pins:** On both Auto-Belay cylinders
- Easy 4 bolt mounting system

Air Pressure:	
Gen 3, 4, & 4.5	Gen 5
85-95 PSI	95-100PSI

2.2.7 AB40 Specs (Generation 5)

The following specifications are associated with a 4th generation AB40:

- **Size:** 9'3" long, 14" wide, and 17" deep
- **Weight:** 214 lbs.
- **Mounting Height:** Typically ground level, remote location okay
- **Climbing Range:** 10'-40'
- **Maximum climbers' weight:** 250 lbs. (113.39 kg)
- **Color:** Black powder coated finish
- **Design:** Dual cylinder-open design
- **Body Material:** Steel
- **Cylinders:** 39" X 2" 2500 PSI (Qty 2)
- Weatherproof hydraulic breather caps (Qty2)
- **Pulleys:** 6" sealed bearing, nylon (Qty 9) for a ¼" cable
- **Oil:** ISO 32
- **Upper Pulley Cart:** 8 sealed bearing
- **Air Pressure:** 95 – 105 PSI operations pressure
- **Hoses:** 2000 PSI
- **Fittings:** #10, O-ring with face seals
- **Hardware:** Grade 8 on pulleys, grade 5 on assemblies
- **Oil Filtration System:** Yes, inline screen
- **Oil Site Glass:** Mounted for clear inspections
- **Pressure Gauge:** 0- 150 PSI
- **Breather Cap:** Low profile
- **1" quick connections pins:** On both Auto-Belay cylinders
- Easy 4 bolt mounting system

2.2.8 AB75 Specs (Generation 5)

The following specifications are associated with a 4th generation AB75:

- **Size:** 9'3" long, 24" wide, and 17" deep
- **Weight:** 370 lbs.
- **Mounting Height:** ground level, remote location okay
- **Climbing Range:** 10' - 75'
- **Maximum climbers' weight:** 250 lbs. (113.39 kg)
- **Color:** Black powder coated finish
- **Design:** Dual cylinder-open design
- **Body Material:** Steel
- **Cylinders:** 39" X 2" 2500 PSI (Qty 2)
- **Pulleys:** 6" sealed bearing, nylon, fits 10.5 mm rope (Qty 9)
- **Oil:** ISO 32 w/blue dye
- **Upper Pulley Cart:** 8 sealed bearing
- **Air Pressure:** 105 - 110 PSI operations pressure (depends on routing)
- **Hoses:** 2000 PSI
- **Fittings:** #10, O-ring with face seals
- **Hardware:** Grade 8 on pulleys, grade 5 on assemblies
- **Oil Filtration System:** Yes, inline screen
- **Oil Site Glass:** mounted for clear inspections
- **Pressure Gauge:** 0- 160 PSI
- **Breather Cap:** Low profile
- **1" quick connections pins:** On both Auto-Belay cylinders
- Easy 4 bolt mounting system

2.3 Auto-Belay Sticker Package (Gen 3, 4, & 4.5)



Figure 1. Auto-Belay Sticker Package (Gen 3, 4, & 4.5)

2.4 Auto-Belay Sticker Package (Gen 5)



Figure 2. Auto-Belay Sticker Package (Gen 5)

3. INSPECTIONS

This section of the manual will provide you with guidelines and checklists for daily, weekly, quarterly, and yearly inspections. This section will also provide you with guidelines for other product-related inspections.



Warning!

Inspections of the Auto-Belay Safety System must occur on a daily/weekly/quarterly/yearly basis to ensure continued, safe operation.



Attention!

All of the information in this chapter of the manual must be understood and implemented. All of the inspections listed in this section must be performed within the time frames specified by this manual.

3.1 Priming the Auto-Belay

Before each use of the Auto-Belay you must do the following:

With one operator on the front of the wall using a rope, manually extend the cable to the top of the wall while a second person inspects the retraction of the cable to ensure that there is **NO SLACK** behind the wall.

Ensure that all pulleys turn when the cable is in motion and that the cable drag is minimal.

The following steps need to be completed before the Auto-Belay Safety System is used (each time the product is used).

- Check the air pressure to confirm that it is within the safe operating range (consult the sticker on the side of your Auto-Belay Safety System).
- Check the cable to ensure that it can travel through the pulleys without restriction.
- Check the oil-site for fluid.
- Pull on the cable (front side of the wall) and make sure that the cable retracts itself. Do this several times, while making sure that the cable has an elastic feel.
- While standing on the front side of the wall (the side that is for climbing), hold on to the cable, raise it above your head, then pull it to the ground (priming the Auto-Belay Safety System). Do this multiple times.

- Once you have primed the system, hook onto the Auto-Belay Safety System (wearing a climbing harness) and climb up 5', then let go, and allow the Auto-Belay Safety System to lower you to the ground.
- Continue to climb up the wall 5' at a time and allow the system to lower you down. Repeat this step until you have reached the top of the wall.
- Once you have ensured that the Auto-Belay Safety System is operating properly you may now allow clients to climb.



Attention!

Remember, fluid levels should be checked when all Auto-Belay routes are anchored to the bottom of the wall (meaning that the carabiner-end of the cable must be in the “start climbing” position). If you have any questions, please contact Spectrum Sports Intl.

For proper and safe Auto-Belay function, it is important that the Auto-Belay is properly pressurized.

3.2 Inspecting Wear Items

The following items are wear items. Along with suggested guidelines for replacement, it is up to you, the operator, to monitor and determine how much use and wear they receive. **When in doubt, replace it! Safety first!**

- **Carabiners:** It is well known that equipment deteriorates progressively with use. It is difficult to give a precise lifetime on some items because it depends on the environment in which they are used. However, surface damage, corrosive wear, mechanical wear, or impairment of the mechanical function of the product can be easily observed.
- **Swivels:** Again, the same warning for the Carabiners applies to the swivels.
- **Pulleys:** Replace when worn.
- **Quick Link:** Replace annually at a minimum or when other inspection techniques require changes.
- **Cables:** Replace annually at a minimum or when other inspection techniques require changes.
- **Auto-Belay Cylinder Seals:** Replace when you start to see excessive oil leakage.
- **Hardware (Pulley Hardware):** Bolts and nylock nuts must be replaced every 12 months.

3.3 Checking Air Pressure

The current Auto-Belay Safety System (Generation 4+) requires air in the tank to operate properly. Confirm that your Auto-Belay Safety System has the correct amount of air pressure (see the table below for details).

The standard air pressures can be seen in the table below. Depending on the installation and the cable route; more air pressure may be required.

Table 4. Recommended Air Pressures

Only Gen 3, 4, & 4.5	PRODUCT	85 PSI (5.8 BAR)	95 PSI (6.5 BAR)	105 PSI (7.2 BAR)	110 PSI (7.6 BAR)
	AB32				
	AB40				
	AB75				
	ALL GEN 5				

3.4 Inspecting the Hydraulic Fluids

The oil lens should have a blue tinted fluid visible. The maximum fluid amount allowed in the Auto-Belay Safety System is 9 quarts. If no fluid is visible, add the following brand name fluids (**ISO 32 fluid is required**):

Table 5. Approved ISO 32 Hydraulic Fluids

BRAND	ISO 32 FLUID NAME
Mobil	DTE-24
Texaco	RANDO-32
Chevron	AW-32

3.5 Cable Inspections

A rigorous inspection routine is not only recommended but required. Proper inspection will eliminate the chance of using a wire rope beyond its useful life. The inspection routine listed is the procedure that should be followed rigorously. This inspection method is visual and adheres to the applicable standards published in the United States.

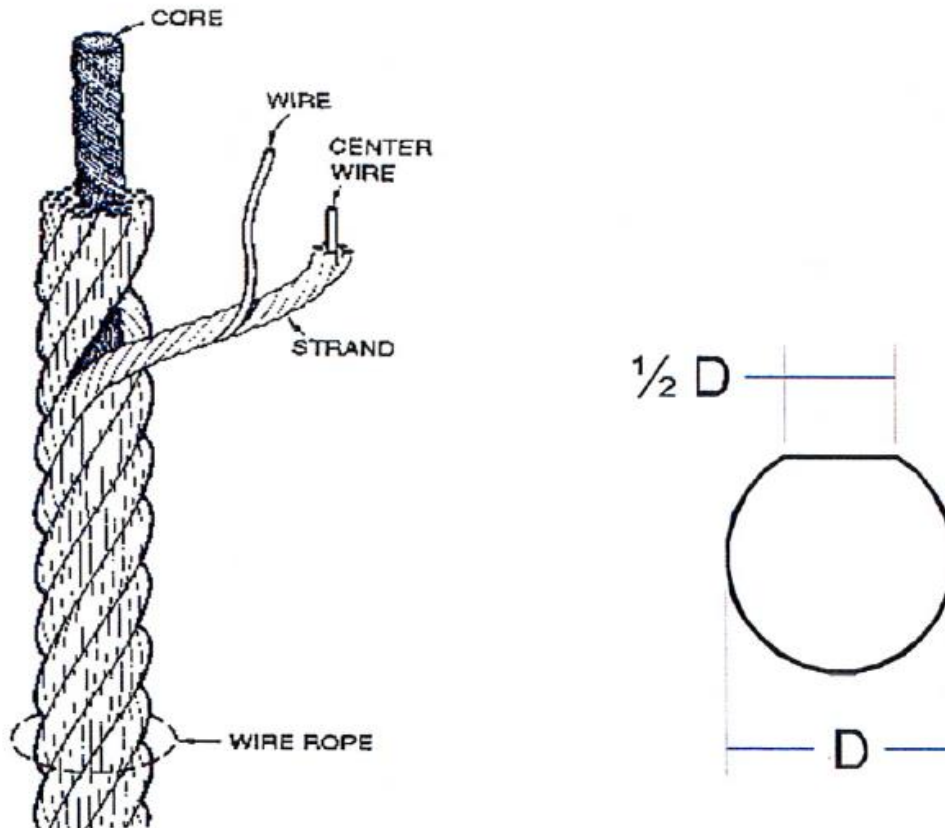

Figure 2. Single Wire Inspection Criteria for the Auto-Belay Wire Ropes.

3.5.1 Replacing the Cable

Replace the cable if any of the following conditions are true (refer to the previous figure):

1. If any of the individual wires in a strand have a flat spot of more than $\frac{1}{2}$ the diameter of the smallest wire as shown in the figure above.
2. If there is a single broken wire in any strand.
3. If there are 50,000 or more cycles on the route.
4. If the cables have been on a climbing tower for 1 year (12 months).
5. If there are any twists, kinks, flat spots, or bird-caging.

Wire Rope Inspection Criteria recommended by various agencies, manufacturers, and governing agencies in the United States have published guidelines pertaining to wire rope use, maintenance, inspection, and general specifications. Most wire rope manufacturers have additional guidelines for the use, maintenance, and inspection of their cables. These guidelines and codes set precedence for the industry standard methods of wire rope use, maintenance, and inspection. Deviation from these recommendations would be viewed as questionable by the most experienced engineers in the industry.

To justify the inspection method recommended by Spectrum Sports Intl, the most noted codes and guidelines have been obtained and read by SAE Inc. engineers. The codes obtained by SAE Inc. engineers include:

- ASME (American Society of Mechanical Engineers) International Publication. ASME/B30.5c – Mobile and Locomotive Cranes, 1998, ISBN#: 0791822753
This code is a revision of the ASME/ANSI B30.5-1989. It applies specifically to applications similar to the Space Shot™ ride.
- Wire Rope Technical Board
Wire Rope User’s Manual, Third Edition, 1993
This test gives a summary compilation of the recommended practices for wire rope use in general applications.
- OSHA Wire Rope Excerpts – General Standards, Vol. 37, Number 202, Oct. 1972.
This general standard is a compilation of the ASME/ANSI standards that exist now as the SME/B30.XX series. These are the forerunner to current standards.
- Leeschen Wire Rope Company – “Wire rope Inspection”, Report #107.
This report gives guidelines to the inspection methods appropriate to identify wire rope damage.

Each of these codes specifies, in general, the same criteria for the inspection of wire ropes. Additional ASME codes specify inspection criteria for additional applications including, but not limited to, personnel hoists (elevators), overhead cranes, material hoists, etc. The ASME code governing *Mobile and Locomotive Cranes* is very stringent. It is the most stringent code that has any applicability to the Auto-Belay. The highlights of the inspection guidelines/codes listed above are included in the next table of this document to set a comparison reference for Spectrum Sports Intl guidelines.

Note: The inspection procedures outlined in the referenced codes are all *visual inspections*.

3.5.2 Cable Replacement Options

The following cable replacement options are available:

- **On-Site Service:** Spectrum Sports Intl has offered the option of On-Site Service for over a decade. Our service truck is fully equipped and circles the entire country twice each year. The On-Site Service option may include cable replacement, parts replacement, inspections, and any other maintenance needs pertaining to the customer’s request.
To be put on the On-Site Service schedule: visit our website at www.spectrumsports.com , then fill out, and submit the request form, or call (888)563-0163.
- **Self-Installation:** Customers who wish to install cables on their own product have the option of ordering certified cable, with both ends crimped, straight from our facility.
Specific instructions for properly installing the cable on a Spectrum Sports Intl Auto-Belay Safety System can be found in Appendix E of this manual.

3.5.3 Wire Rope Inspection Comparison

A wire rope inspection criteria comparison can be seen in the table below:

Table 6. Wire Rope Inspection Comparison

INSPECTION CRITERIA REQUIRING ROPE REPLACEMENT	ASME/B30.5C CRANES	WIRE ROPE USERS GUIDE, 3 RD EDITION
Length of Wire Rope Service	No specifications given.	No specifications given.
Abrasion	1/3 diameter worn on any wire (see below).	1/3 diameter worn on any wire, see specific governing code.
Rope Stretch	No specifications given.	When the rate of stretch increases after initial break-in period.
Reduction in Rope Diameter	1/48" on cables 1/4" diameter.	When accompanied with significant rope stretch; otherwise not specific.
Corrosion	Not specified.	If accompanied by metal pitting; if rust exists.
Kinks, Twists, Crushing	Any – replace wire rope.	Any – replace unless cable is repairable.
“Bird Caging”	Any defect – replace unless defect can be removed.	Any defect – replace unless defect can be removed.
Heat/Electrical	Any – replace wire rope.	If wires are fused or discolored.
Broken Strands	Rotation resistant ropes: 2 wires in 6 rope diameters – and 4 wires in 30 rope diameters. New criteria: 4 broken wires in one lay-length and 2 broken wires within 1 strand within 1 lay-length.	See specific code.
Damaged End Attachments	If non-repairable, replace wire rope.	See specific code.
Non-destructive	Not specified	Not specified.

The ASME/B30.5 inspection criterion is very specific on the visual inspections required. The code is specifically designed to allow an inspector to accurately infer the status of the wire rope core from a thorough inspection of the wire ropes broken wires in a strand, abrasion of the wires in the strands, and the change in the diameter of the overall rope. The inspection criterion requires a thorough visual inspection of the rope.

The number of broken strands is a key aspect of all of the ASME codes. Due to the primary role, it plays in determining the integrity of the rope core, a summary of the ASME code allowable broken strands can be seen in the table below.

Table 7. Allowable broken strands by ASME Code

ASME STANDARD	EQUIPMENT CONNECTION	NUMBER OF BROKEN WIRES IN RUNNING ROPES		NUMBER OF BROKEN WIRES IN STANDING ROPES	
		IN ONE		IN ONE	
		ROPE LAY	STRAND	ROPE LAY	STRAND
ASME/B30.2	Overhead & Gantry Cranes	12**	4	Not Specified	
ASME/B30.4	Portal, Tower, & Pillar Cranes	6**	3	3	2
ASME/B30.5	Crawler, Locomotive & Truck Cranes: Retirement criteria based on number of broken wires rev B. Rotation Resistant Rope found in length of rope equal to 6x rope diameter – 2 broken wires maximum; and 30x rope diameter – 4 broken wires maximum.				
ASME/B30.5	Running Rope	6**	3	3	2
ASME/B30.6	Derricks	6**	3	3	2
ASME/B30.7	Base Mounted Drum Hoists	6**	3	3	2
ASME/B30.8	Floating Cranes & Derricks	6**	3	3	2
ASME/B30.16	Overhead Hoists	12**	4	Not Specified	
ANSI/A10.4	Personnel Hoists	6**	3	2**	2
ANSI/A10.5	Material Hoists	6**	Not Specified		

****Also remove for 1 valley break**

3.6 Daily Inspections

Please note that these inspection guidelines are a minimum. Take caution and ensure that any and all working parts and safety related products are thoroughly inspected and that all bolts are secure before use. As a means of properly maintaining the Auto-Belay Safety System and ensuring proper safety for the climber, a daily inspection is required. The checklist in section 3.10.2 should be followed and completed daily.

You may download a Daily Inspection Checklist from www.spectrumsports.com.

3.7 Weekly Inspections

Weekly inspections are intended to be more in-depth than daily inspections. On the Auto-Belay Safety System, no component will fail without first revealing warning signs due to wear or damage. In conjunction with the daily inspections, the weekly inspections should be sufficient to find any potential problem well before failure becomes imminent. The checklist in section 3.10.3 should be followed and completed on a weekly basis.

You may download a Weekly Inspection Checklist from www.spectrumsports.com.

3.8 3-Month Inspections

3-month inspections are intended to be more in-depth than daily or weekly inspections. On the Auto-Belay Safety System, no component will fail without first revealing warning signs due to wear or damage. In conjunction with the daily and weekly inspections, 3-month inspections should be sufficient to find any potential problem well before failure becomes imminent. The checklist in section 3.10.4 should be followed and completed on a 3-month basis.

You may download a 3 Month Inspection Checklist from www.spectrumsports.com.

3.9 12-Month Inspections

12-month inspections are intended to be more in-depth than the prior inspections and include a mandatory replacement of parts. On the Auto-Belay Safety System, no component will fail without first revealing warning signs due to wear or damage. In conjunction with all the prior mentioned inspections, the 12-month inspections should be sufficient to find any potential problem well before failure becomes imminent. The checklist in section 3.10.5 should be followed and completed on an annual (12 month) basis.

You may download a 12 Month Inspection Checklist from www.spectrumsports.com.

3.10 Inspection Checklists

3.10.1 Quick Reference Checklist

Table 8. Quick Reference Inspection Checklist

INSPECT THIS:	DAILY	WEEKLY	3 MONTH	12 MONTH
Cable has tension on it (No slack)	X			
Cable Crimps	X			
Cable for any broken wires, twists, kinks, or flat spots	X			
Air Pressure	X			
Oil level	X			
*Proper priming of Auto-Belay (see below)	X			
Cable tracks in the pulley's correctly	X			
Carabiner	X			
Quick Link	X			
Harnesses	X			
Swivel	X			
Pulleys for wear or damage		X		
Hydraulic Hoses		X		
Harnesses (See Appendix I)		X		
Visual Inspection		X		
Auto-Belay mounting bolts			X	
Davit Mounts/Hardware/pulleys			X	
Cable Replacement				X
Hardware replacement				X
Connection Hardware				X

3.10.2 Daily Inspection Checklist

Table 9. Daily Inspection Checklist

CLIMBING ROUTES					Daily Inspection Check list				
1	2	3	4	5	Cable Inspections				
6	7	8	9	10	Verify that the cables are up to date on their certification. Check every inch of cable for the following: Broken wires, "bird-caging", twists, kinks, or flat spots greater than 1/2 the diameter of a single strand. If any apply, replace immediately.				
(Check off applicable route after each step.)									
1	2	3	4	5	Cable Termination Inspections				
6	7	8	9	10	Ensure that cable ends are secure and termination points are secure. Lift up the hose on the climbing end of the cable to inspect the crimped ends				
1	2	3	4	5	Pulley Cart				
6	7	8	9	10	Ensure that the pulley cart is free from debris and any particles from wall surface. Check to ensure that the pulley cart is not obstructed in any way. Check bearing wheels for proper contact				
1	2	3	4	5	Cable Slack				
6	7	8	9	10	Ensure there is NO slack in front or behind the climbing structure/wall. There should always be tension on the cable!!				
1	2	3	4	5	Air Pressure				
6	7	8	9	10	<i>(Write in the air pressure in the square to the left NOT a check mark!)</i>				
					Look at the sticker on the side of the AB tank to ensure proper air pressure for each AB system				
1	2	3	4	5	Hydraulic Fluid				
6	7	8	9	10	Hydraulic fluid level should be visible in oil eye/lens. ISO 32 fluid is required; the following name brand fluids are available: MOBILE DTE-24, TEXACO RANDO-32, and CHEVRON AW-32.				
1	2	3	4	5	Attachment Hardware				
6	7	8	9	10	Carabineer – If the auto-locking Carabineer is not locking positively or if it is sticking open, replace immediately. Swivel- Needs to spin freely without sticking. Quick Link - Must be tighter than "finger tight".				
1	2	3	4	5	Auto - Belay Priming				
6	7	8	9	10	Ensure that the Auto-Belay has been properly primed. (See page 8 "Priming of the Auto-Belay")				
Comments:									
Operator:									
Date:									
Questions call; 888-563-0163 Spectrum Sports Int'l, www.spectrumsports.com									

3.10.3 Weekly Inspection Checklist

Table 10. Weekly Inspection Checklist

CLIMBING ROUTES					Weekly Inspection Check list
1	2	3	4	5	Cable Inspections
6	7	8	9	10	Verify that the cables are up to date on their certification. Check every inch of cable for the following: Broken wires, "bird-caging", twists, kinks, or flat spots greater than 1/2 the diameter of a single strand. If any apply, replace immediately.
<i>(Check off applicable route after each step.)</i>					
1	2	3	4	5	Cable Termination Inspections
6	7	8	9	10	Ensure that cable ends are secure and termination points are secure. Lift up the hose on the climbing end of the cable to inspect the crimped ends
1	2	3	4	5	Pulley Cart
6	7	8	9	10	Ensure that the Pulley cart is free from debris and any particles from wall surface. Check to ensure that the pulley cart is not obstructed in any way. Check bearing wheels for proper contact.
1	2	3	4	5	Cable Slack
6	7	8	9	10	Ensure there is NO slack in front or behind the climbing structure/wall. There should always be tension on the cable!!
1	2	3	4	5	Air Pressure
6	7	8	9	10	<i>(Write in the air pressure in the square to the left NOT a check mark!)</i> Look at the sticker on the side of the AB tank to ensure proper air pressure for each AB system
1	2	3	4	5	Hydraulic Fluid
6	7	8	9	10	Hydraulic fluid level should be visible in oil eye/lens. ISO 32 fluid is required; the following name brand fluids are available: MOBILE DTE-24, TEXACO RANDO-32, and CHEVRON AW-
1	2	3	4	5	Attachment Hardware
6	7	8	9	10	Carabineer – If the auto-locking Carabineer is not locking positively or if it is sticking open, replace immediately. Swivel- Needs to spin freely without sticking. Quick Link - Must be tighter than "finger tight".
1	2	3	4	5	Pulley Wear and Inspection
6	7	8	9	10	Inspect pulleys for excessive wear, cracks or splits. This is accomplished by rotating the pulley and inspecting the groove for wear depth. The pulleys should not wiggle side-to-side during operation. Replace if any damage is present.
1	2	3	4	5	Hydraulic Cylinders
6	7	8	9	10	Inspect for any oil leakage around fittings, site gauge, hoses, plugs, and oil containment systems. Some seepage is expected during normal use. Check for pitting and abrasions. Tighten and document any alterations to the system.
1	2	3	4	5	Visual Inspection
6	7	8	9	10	Vissually inspect all structural components: Wall frame, davits, trailer, etc for damage or cracking.
1	2	3	4	5	Auto - Belay Priming
6	7	8	9	10	Ensure that the Auto-Belay has been properly primed. (See page 8 "Priming of the Auto-Belay")
Comments:					
Operator					
Date					
Questions call:					888-563-0163 Spectrum Sports Int'l, www.spectrumsports.com

3.10.4 3 Month Inspection Checklist

Table 11. 3 Month Inspection Checklist

CLIMBING ROUTES					3 Month Inspection Check list				
1	2	3	4	5	Cable Inspections				
6	7	8	9	10	Verify that the cables are up to date on their certification. Check every inch of cable for the following: Broken wires, "bird-caging", twists, kinks, or flat spots greater than 1/2 the diameter of a single strand. If any apply, replace immediately.				
(Check off applicable route after each step.)					Cable Termination Inspections				
1	2	3	4	5	Ensure that cable ends are secure and terminations points are secure/lift up the hose on the CABLE to inspect the Crimped ends				
6	7	8	9	10					
					Pulley Cart				
1	2	3	4	5	Ensure that the pulley cart is free from debris and any particles from wall surface. Check to ensure that the pulley chart is not obstructed in any way. Check bearing wheels for proper contact				
6	7	8	9	10					
					Cable Slack				
1	2	3	4	5	Ensure there is NO slack in front or behind the climbing structure/wall. There should always be tension on the cable!!				
6	7	8	9	10					
					Air Pressure				
1	2	3	4	5	<i>(Write in the air pressure in the square to the left NOT a check mark!)</i>				
6	7	8	9	10	Look at the sticker on the side of the AB tank to ensure proper air pressure for each AB system				
					Hydraulic Fluid				
1	2	3	4	5	Hydraulic Fluid level should be visible in oil eye/lens. ISO 32 fluid is required; the following name brand fluid is available: MOBILE DTE-24, TEXACO RANDO-32, and CHEVRON AW-32.				
6	7	8	9	10					
					Attachment Hardware				
1	2	3	4	5	Carabineer – If the auto-locking Carabineer is not locking positively or if it is sticking open, replace immediately. Swivel- Needs to spin freely without sticking. Quick Link - Must be tighter than "finger tight".				
6	7	8	9	10					
					Pulley Wear and Inspection				
1	2	3	4	5	Inspect pulleys for excessive wear, cracks or splits. This is accomplished by rotating the pulley and inspecting the groove for wear depth. The pulleys should not wiggle side-to-side during operation. Replace if any damage is present.				
6	7	8	9	10					
					Hydraulic Cylinders				
1	2	3	4	5	Inspect for any oil leakage, around fittings, site gauge, hoses, Plugs, and oil containments systems. Some seepage is expected during normal use. Check for pitting and abrasions. Tighten and document any alternations to the system.				
6	7	8	9	10					
					Visual Inspection				
1	2	3	4	5	Vissually inspect all structural components: Wall frame, davits, trailer, etc for damage or cracking.				
6	7	8	9	10					
					Mounting Hardware				
1	2	3	4	5	Inspect all mounting hardware on the Auto-Belay and the davits.				
6	7	8	9	10					
					Oil Containment System				
1	2	3	4	5	Inspect all fittings and check for leaks. Document the amount of fluid in each bottle. Refer to owners manual for more information.				
6	7	8	9	10					
					Auto - Belay Priming				
1	2	3	4	5	Ensure that the Auto-Belay has been properly primed. (See page 8 "Priming of the Auto-Belay")				
6	7	8	9	10					
Comments:									
Operator									
Date									
Questions call;		888-563-0163 Spectrum Sports Int'l , www.spectrumsports.com							

3.10.5 12 Month Inspection Checklist

Table 12. 12 Month Inspection Checklist

CLIMBING ROUTES					12 Month Inspection Check list				
1	2	3	4	5	Cable Inspections				
6	7	8	9	10	⚠️ Cable must be replaced with certified Spectrum Sports Intl cable. Check every inch of cable for the following: Broken wires, "bird-caging", twists, frays, kinks, or flat spots greater than 1/2 the diameter of a single strand. If any apply, replace immediately.				
(Check off applicable route after each step.)									
1	2	3	4	5	Cable Termination Inspections				
6	7	8	9	10	Ensure that cable ends are secure and terminations points are secure/lift up the hose on the CABLE to inspect the Crimped ends				
1	2	3	4	5	Pulley Cart				
6	7	8	9	10	Ensure that the pulley cart is free from debris and any particles from wall surface. Check to ensure that the pulley chart is not obstructed in any way. Check bearing wheels for proper				
1	2	3	4	5	Cable Slack				
6	7	8	9	10	Ensure there is NO slack in front or behind the climbing structure/wall. There should always be tension on the cable!!				
1	2	3	4	5	Air Pressure				
6	7	8	9	10	<i>(Write in the air pressure in the square to the left NOT a check mark!)</i> Look at the sticker on the side of the AB tank to ensure proper air pressure for each AB system.				
1	2	3	4	5	Hydraulic Fluid				
6	7	8	9	10	Hydraulic Fluid level should be visible in oil eye/lens. ISO 32 fluid is required; the following name brand fluid is available: MOBILE DTE-24, TEXACO RANDO-32, and CHEVRON AW-32.				
1	2	3	4	5	Attachment Hardware				
6	7	8	9	10	Carabineer – If the auto-locking Carabineer is not locking positively or if it is sticking open, replace immediately. Swivel- Needs to spin freely without sticking. Quick Link - Must be tighter than "finger tight".				
1	2	3	4	5	Pulley Wear and Inspection				
6	7	8	9	10	Inspect pulleys for excessive wear, cracks or splits. This is accomplished by rotating the pulley and inspecting the groove for wear depth. The pulleys should not wiggle side-to-side during operation. Replace if any damage is present.				
1	2	3	4	5	Hydraulic Cylinders				
6	7	8	9	10	Inspect for any oil leakage, around fittings, site gauge, hoses, Plugs, and oil containments systems. Some seepage is expected during normal use. Check for pitting and abrasions. Tighten and document any alternations to the system.				
1	2	3	4	5	Visual Inspection				
6	7	8	9	10	Vissually inspect all structural components: Wall frame, davits, trailer, etc for damage or				
1	2	3	4	5	Mounting Hardware				
6	7	8	9	10	Inspect all mounting hardware on the Auto-Belay and the davits.				
1	2	3	4	5	Oil Containment System				
6	7	8	9	10	Inspect all fittings and check for leaks. Document the amount of fluid in each bottle. Refer to owners manual for more information.				
1	2	3	4	5	Pulley Hardware				
6	7	8	9	10	All pulley bolts and applicable Nylock nuts must be replaced.				
1	2	3	4	5	Auto - Belay Priming				
6	7	8	9	10	Ensure that the Auto-Belay has been properly primed. (See page 8 "Priming of the Auto-Belay")				
Comments:									
Operator:									
Date:									
Questions call;	888-563-0163 Spectrum Sports Int'l, www.spectrumsports.com								

3.11 Stationary Climbing Wall Inspections

Use the following Table to assist you with your inspections. For daily, weekly inspection forms, go to www.spectrumsports.com and print off as needed.

Table 13. Stationary Climbing Tower Inspection Checklist

INSPECT THIS:	DAILY	WEEKLY	QUARTERLY
Auto- Belay checklist	X		
Check for loose handholds	X		
Buzzers work properly	X		
Tree Fronds are secured (CTC only)	X		
Elements are secure and ready to use (CNC only)	X		
Visually inspect each climbing zone for each climbing route	X		
Harnesses	X		
Visually inspect the banners are secured (CTC & CNC)		X	
Visually inspect all mounting hardware		X	
Visually inspect climbing panel to the steel		X	
Visually inspect climbing surfaces for foreign objects		X	
Clean and inspect hoses on the Auto-Belay cable		X	
Harnesses (See Appendix I)		X	
Confirm anchor hardware is torqued properly			X
Confirm back steel bracing is secure and hardware tight			X
Visually inspect all welds			X



Attention!

Spectrum Sports Intl recommends the following inspection for the steel climbing wall structures. It is your responsibility to ensure that you follow our recommendation. Failure to comply will result in non-compliance and therefore no manufacturers liability coverage will be available.

3.11.1 Non-Destructive Examination (NDE) Inspection Policy

Spectrum Sports Intl has had a third-party structural analysis for all of our products since 2004. These analyses call out for “visual inspections” for specific items.

Spectrum Sports Intl requires visual inspections of the applicable items as called out in the “Inspections” section of this product owners/operators manual.



Attention!

The documented daily, weekly, quarterly, and annual inspections must be completed to ensure safe operations of all products.

4. Prep the Auto-Belay

4.1 Priming of the Auto-Belay

This **MUST** be completed when the climbing tower is vertical

Before each use of the Auto-Belay Safety System you **MUST** complete the following:

- With one operator on the front of the wall, using a rope, manually extend the cable to the top of the wall while a second person inspects the retraction of the cable to ensure there is **NO SLACK** behind the wall.
- Ensure that all pulleys turn when the cable is in motion and that cable drag is minimal.

The following steps need to be done before the Auto-Belay Safety System is used (each time):

1. Check the air pressure to confirm that it is within the safe operating range (consult the sticker on the side of your Auto-Belay Safety System).
2. Check the cable to ensure that it can travel through the pulleys without restriction.
3. Check the oil-site for fluid.
4. Pull on the cable (front side of the wall) and make sure that the cable retracts itself, do this several times, and make sure that the cable has an elastic feel.
5. While standing on the front side of the wall (the side that you climb on), hold on to the cable, raise it above your head, and pull it to the ground (priming the Auto-Belay Safety System). Do this multiple times.
6. Once you have primed the system, hook into the Auto-Belay Safety System, and climb up 5', then let go, allowing the Auto-Belay Safety System to lower you to the ground.
7. Continue to climb up the wall 5' at a time and allow the system to lower you down, repeat until you have reached the top of the wall.
8. Once you have ensured that the Auto-Belay Safety System is operating properly, you can allow clients to climb.



Attention!

Remember, fluid levels should be checked when the Climbing Tower is in a vertical position. Ensure that all Auto-Belay Safety System routes are anchored to the bottom of the wall using the carabiner-end of the cable. If you have any questions, please call Spectrum Sports Intl.

For proper and safe Auto-Belay function, it is important that the Auto-Belay Safety System is properly pressurized

5. OPERATING THE AUTO-BELAY

Once you understand how the Auto-Belay Safety System works, and how to inspect it, you need to understand how to operate it. Follow the steps below to ensure safe usage of the Auto-Belay system.



Attention!

Make sure you read and understand this section thoroughly before using the product.

Complete the following steps to operate the Auto-Belay Safety System:

1. Complete the daily checklist.
2. Confirm that the cable has tension in it.
3. Before someone climbs, instruct the climber regarding the proper protocol to follow during and after climbing. This includes the following:
*When a climber has finished climbing (reaches the top, falls, or cannot support themselves while climbing), inform them to grab hold of the red hose on the cable and “sit” in the harness with their feet toward the climbing structure. This will allow the Auto-Belay Safety System to slowly lower the climber. **Inform the climber to land on their feet first!***
4. Confirm that the climbing harness is secure and on properly.
5. Unhook the Auto-Belay cable from the static/locked position and hook it to the climbing harness. **Be sure that you hear the carabiner click into the locked position!** Double check the tension on the cable by pulling down and feeling the up pull.
6. Instruct the climber on how to climb, meanwhile paying attention to the tension on the cable.



Warning!

If slack occurs at any time during the climb, STOP CLIMBING UP and slowly climb down. DO NOT LET GO and fall with slack in the cable. Serious injury may occur.

7. Once the climber has descended and is standing on the ground, unhook them from the Auto-Belay Safety System. Once they are “OFF” the Auto-Belay Safety System, remove the climbing safety harness from them.



Warning!

DO NOT ALLOW THEM TO CLIMB ON THE TOWER WITHOUT A HARNESS OR BEING SECURED INTO THE AUTO-BELAY SAFETY SYSTEM.

8. Remove the person from the “Climbing Zone.”

6. CLIMBING OPERATIONS

This section will explain the proper climbing procedures for personnel and customers.

6.1 Required Personnel for Operations

For efficient setup and operations, Spectrum Sports Intl recommends that at least two people operate the product for optimal performance and safety. Spectrum Sports Intl recommends that one-person acts as the climbing coach (Climb Master), supervising any one or all of the climbers that are on the climbing tower. The second person (Assistant) will harness the climber, contain the “Climbing Zone” and (if required by the event or your insurance) obtain a parental consent or hold harmless signature. The Climb Master should offer encouragement, entertain the climber, and most importantly watch the Auto-Belay cable to ensure that there is no excess slack in the cable or that the climber does not out climb the Auto-Belay device. The Assistant should ensure that the harness is worn correctly. You need to decide how many personnel are needed to ensure that safe operations are taking place. When in doubt, add another trained personnel to the attraction.

By way of recommendation, as the climber climbs the unit, the Climb Master should be interactive by offering positive words of encouragement and possible hand or foothold suggestions. As a climber descends after having climbed to the top, make sure the area on the ground is free of any individual who could possibly get in the way of the rappelling climber. The distance we recommend is approximately six (6) feet from the front surface of the climbing product. The only person who should be in this six-foot area is the Climb Master. Upon the completion of a climb, the climber must wait for direction from the climbing coach before proceeding to the harness area for removal of the climbing harness. Likewise, the upcoming climber must be advised by either the Climb Master or the Assistant ensuring proper fitting of the harness before proceeding to climb on the wall. This will ensure that a rappelling climber will not descend onto an upcoming climber.



Attention!

As an additional note, although Climbing Helmets are not required, we strongly recommend their use.

6.1.1 Climb Master Duties

The roles for the Climb Master are as follows:

- Confirms each climbing zone is safe to climb (test the Auto-Belay Safety System before each climb; see the Auto-Belay Safety System section in this manual).
- Ensure that each climber is secured into his/her climbing harness properly.
- Certify that the climber understands the rules of climbing on the Climbing Tower.
- Affirm that the climber understands what the climber is to expect once they decide to come down off the tower.
- Ensures that the climbing route is free from any other climbers.
- Ensures that the climber is able to climb (see that the “Warning & Safety” and “Rules” signs are followed).

- Makes sure that the Auto-Belay Safety System is retracting the cable.
- Act as a coach with encouragement and guidance.
- Be positive and happy while working with the Climbing Tower.
- Keep the flow moving smoothly and safely in the “Climbing Zone.”
- Complete all of the “Assistant’s” responsibilities if you are working the climbing tower alone.

6.1.2 Assistant Duties

The roles for the Assistant are as follows:

- Ensure that the climbers understand the Rules and Warnings of the Climbing Towers.
- Explain what is to be expected during the climbing experience on the Climbing Towers.
- Place the climbers in the climbing harness.
- Verbally explains to the climber the Rules and Warnings.
- Collect any tokens/tickets or money for the climbing tower.
- Keep the climbers out of the Climbing Zone until the Climb Master calls for them.
- Keep the Climbing Zone free and clear of any “NON” climbers.
- Maintain the que line in orderly fashion.



Attention!

Ultimately it is your responsibility to ensure that each person that climbs on the Climbing Tower is safe! Practice safety first. Know the product and how it works.

6.2 Climbing Zones

We highly recommend that you have a minimum of 6’ of clearance around the climbing tower for the “Climbing Zone.” This area is strictly used for the participants of the climbing tower and the Climb Master. The Climbing Zone allows for safe and ease of operations. Please ensure that you keep this area clear of any obstacles and/or distraction.

Climbing Zone examples can be seen in the following figures.

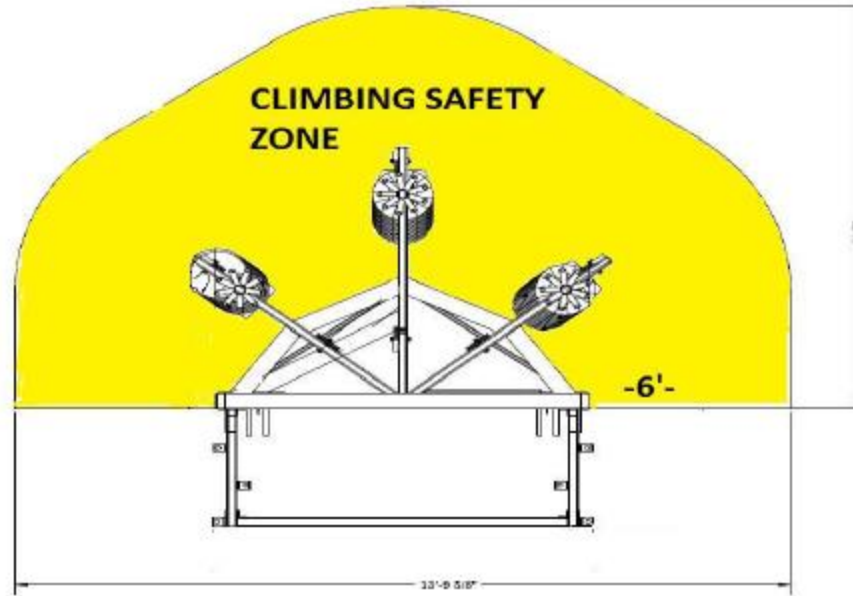
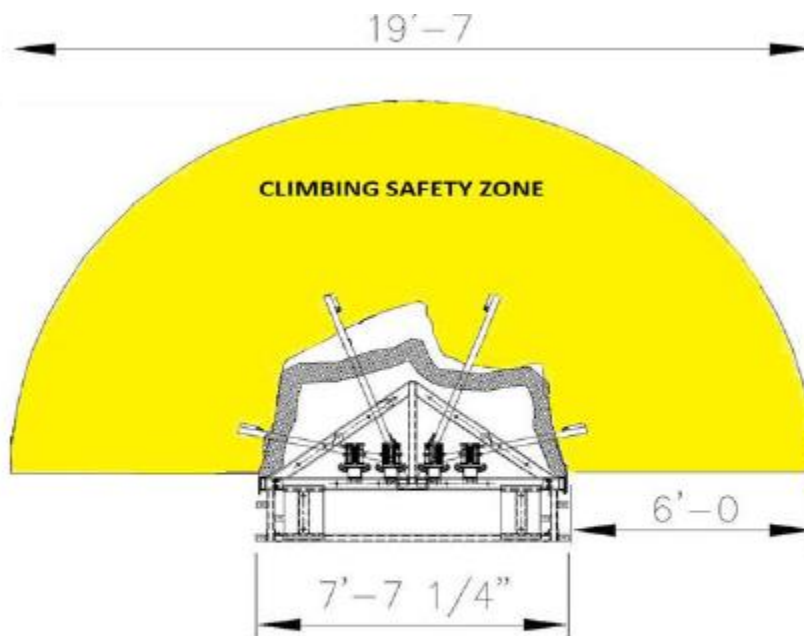

Figure 3. Coconut Tree Climbing Safety Zone



DROP A ROCK Climbing Safety Zone

Figure 4. DROP-A-ROCK Climbing Safety Zone

6.3 Rules and Safety Tips

Ensure that the Climb Master has double-checked the wearing of the harness and has properly instructed the climber on the following climbing rules:

1. Climbers stay within the respective climbing route. The four-foot area directly under the belay cable outlines the climbing area.
2. No swinging from side to side.
3. No stepping on the belay cable.
4. No climbing if cable does not retract.
5. Communicate with the Climb Master only. No distracting other climbers with idle conversation.
6. When rappelling, DO NOT kick off the tower (CTC & CNC only). Sit in the harness and place your hands on the red hose.
7. No climbing with shoes without toes or toe protection (i.e., no sandals, thongs, etc.).
8. DO NOT allow a climber to climb beyond the top of the unit. A climber should never climb higher than head high to the top of the wall.
9. The weight range for the unit is 40 lbs. – 250 lbs.
10. The minimum height for climbing is 40" tall.
11. The minimum age for climbing is 6 years old.
12. Do not allow someone to sit and bounce on the belay cable when they have finished rappelling. Have them rappel onto their feet.

6.4 Emergency Climber Recovery

It may be necessary for the Climb Master to climb the product to retrieve a person who may be frozen in place or afraid to come down after they have climbed to a specific height. If this is the case, the emergency guideline is to have the Assistant place the Climb Master a climbing harness. Once the climbing harness is secure, the assistant will connect the Auto-Belay Safety System to the Climb Master on the route next to the person in trouble and climb up to the person. If the Climb Master cannot talk the person down, the Climb Master must grab the Auto-Belay cable that is attached to the person in trouble and pull and drop to the ground at the same time, the weight of the Climb Master will pull the person off the wall and the Auto-Belay Safety System(s) will lower them both to the ground safely.



Warning!

NEVER REMOVE THE AUTO-BELAY Safety System Cable or Carabiner from any climber or participant while they are climbing on the climbing tower.

7. MAINTENANCE

7.1 Maintenance & Service

We recommend that you follow the manufacturer's guidelines for the maintenance on your Climbing Tower. **Under no circumstances should any unqualified person(s) service the unit.** Any work to the steel frame, fiberglass body, hydraulic Auto-Belay Safety System, and cabling should be performed by an experienced person in the field of service who is certified, bonded, etc., to perform the work. It is the owners' responsibility to ask for such certification and/or bonding verification.

Follow the Manufacturer's checklists and keep records of all your maintenance. We recommend that you keep a service log, inspection log, and all receipts/invoices that pertain to your product.

Spectrum Sports Intl offers **On-Site** service for your confidence and safety. We offer the following services:

- Cable change outs
- Product training
- Inspections
- Minor product repair
- Auto-Belay Safety System rebuilds

Visit our website www.spectrumsports.com to sign up for our On-Site service and view more service options.



Warning!

Spectrum Sports Intl will not warranty or stand behind any Stationary Climbing Tower and/or Auto-Belay Safety System that we have manufactured that does not use genuine and/or authorized replacement parts and/or cable. Any work and/or service that is performed on any Spectrum Sports Intl Auto-Belay Safety System that is not performed by an authorized Spectrum Sports Intl employee, voids any and all claims to any manufacturer's liability.

7.2 Service Options

The following service options are available:

- **On-Site Service:** Spectrum Sports Intl has offered the option of On-Site Service for over a decade. Our service truck travels the U.S. twice each year and is fully equipped. Service that aligns with the truck's schedule can be offered at a very competitive rate. The service offered may include cable replacement, parts replacement, inspection, and any other maintenance needs pertaining to the customers' request. To be added to the On-Site Service schedule, visit our website at www.spectrumsports.com to complete and submit the request form, or call (435) 792-3883.

- **Self-Installation:** Customers who wish to do their own maintenance have the option of ordering certified OEM parts directly from Spectrum Sports Intl. The customer then assumes all liability for the work, but the part is still covered by the manufacturer's warranty provided it is installed and used properly.
- **3rd Party Service:** Spectrum Sports Intl does not train, nor authorize, 3rd party vendors to service its products. If any 3rd party purports to be an authorized Spectrum Sports Intl servicer, please report it to us immediately.

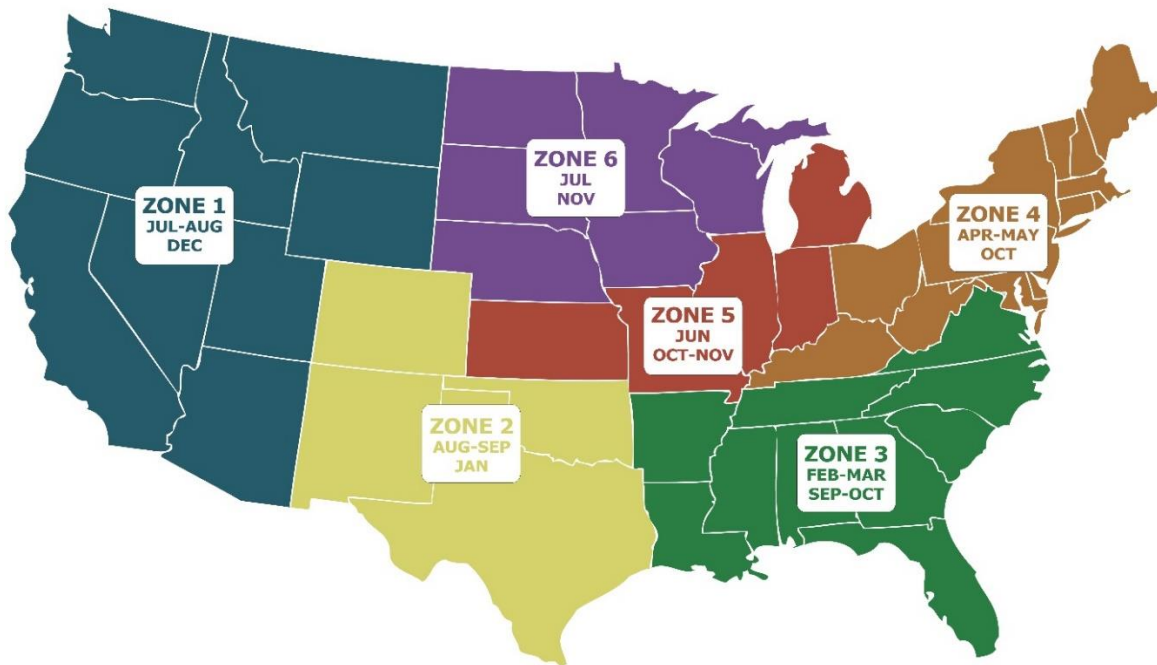

7.3 Cleaning

Cleaning of the unit should be similar to an automobile (i.e., car wash with spray washers and mild detergents). We recommend that you dry the climbing tower after each time you clean it.

Wash with mild cleaners and rinse pressures. Dry the product completely before use or storage. **Do not allow water to sit or dry on the product.** The following items may be washed:

- Steel frame
- Auto-Belay Safety System
- Climbing surface
- Tree surface
- Elements
- Banners
- Tree Fronds

We do recommend using a furniture polish (without natural oils) to help keep all steel clean and polished. It places a light layer of wax on the steel that helps protect it and refreshes the finish. This also allows you to look at the welds and inspect the product.

- For harnesses, and other items not listed above please refer to the original manufacturer's recommendations.
- Handhold cleaning is best performed using a "citrus degreaser" (type of detergent) and a sprayer at a local car wash.



Attention!

Use caution if you use a pressure washer. DO NOT put the nozzle directly on the product, you may damage the product.

Do not use any mineral spirits, acids, or other harmful chemical products on your Climbing Towers.

7.4 Product Storage (Winterization)

If your Climbing Tower will not be in service for a period of 30 days or more, we recommend the following procedures to keep it free from defects and in optimal operating condition:

- Store cables so that the Auto-Belay cylinders are retracted at bottom of product.
- Depressurize (release air pressure) from belay tanks.
- Disconnect battery cables from battery by disconnecting ground cable first.
 - Store the battery indoors and off the ground.
- Lubricate the T-nuts and handhold bolts with a silicone lubrication spray from backside of climbing wall.
- Cover the horn with a plastic bag.
- Remove swivels and carabiners and attach the cable to bolt hanger with quick link.
- Place all items that are removable in a dry location (harnesses, signs, banners, etc.).
- Store the entire product under a roof or tarp.

If you have any questions or concerns, please call Spectrum Sports Intl at (435)792-3883 or email us at service@spectrumsports.com.

8. WARRANTY

8.1 Warranties and Liabilities

The warranty is established from the date of invoice.

Product Warranty: 90 Days. Wear parts are not included under this warranty. Warranty is only extended to the original owner after 90 days per the following:

- *Steel Frame* – Limited Lifetime on upper pulley cart and belay tank. Does not include any frame damage due to improper installation or damage due to misuse.
- *Powder Coating* – 90 Days. Does not include any blemish due to normal wear and/or abusive use. Warranty is limited.
- *Hydraulic Cylinder(s)* – 90 days per manufacturer specifications. Does not include normal wear and tear. Void if determined that any other hydraulic fluid, other than what has been specified by manufacturer, has been used. If you have questions, please call Spectrum Sports Intl.
- *Cable (Spectrum Sports Intl Certified)* – 90 Days.
- *Climbing Surface*- 90 days. On climbing surfaces, it is not unusual to have cracks and air pockets in the part. This is normal and repair of this is NOT covered under this warranty
- *Steel Trailer and Steel Tower Uppers*- 1 year on welds and structure. Any cracks in the steel must be reported to Spectrum Sports Intl immediately and we will determine if the crack is structural, or operator error is step up.
- *Handholds, Banners, Timers, and other misc. parts*- 90 Days. Wear and Tear is NOT included under this warranty.

General warranty conditions do NOT include shipping costs to Spectrum Sports Intl.

On items that can be shipped by US Postal and/or overnight parcel carriers, Spectrum Sports Intl will pay for the same class or rate of service on return shipment as it was received from customer. Spectrum Sports Intl uses fabricators, distributors and/or service agents local to customer for steel, fiberglass, and hydraulic parts to determine cause and/or repair of this particular part. Should it be determined that the defect is due to abuse or misuse, any and all warranty rights or responsibilities are void. Spectrum Sports Intl reserves the right to void warranty service on any modification to product done by customer. Spectrum Sports Intl is in no way responsible for lost revenue or income while product is not in operation due to warranty or any other problems due to installation and/or operations.

Spectrum Sports Intl: Limited Warranty, Limited Remedy, and Liability Release



Attention!

It is important to read all of the components of this manual and form.

Limited Warranty:

Spectrum Sports Intl warranties and obligations set forth below are in lieu of any other express warranties or obligations of Spectrum Sports Intl, its distributors, or resellers/retailers. The warranties and limitations extend only for the person who originally purchased the product.

Per the warranty section of this manual, Spectrum Sports Intl for a period of 90-days or lifetime, depending upon the item or stated claim (see Warranty section) from date of purchase will at manufacturer's option, repair or replace at no charge, and Spectrum Sports Intl CLIMBING TOWERS & AUTO-BELAY SAFETY SYSTEM which breaks or is defective in materials or workmanship. Damage due to misuse, abuse, or modification is excluded – as is normal wear (such as indicated in the warranty section), dings, scratches, seal wear, cable wear, pulley wear, etc.

Any modifications to any part of the Spectrum Sports Intl product or modifications of any of the third-party products that are included with the product, will forfeit any warranty claim. The product must be in the original form from the manufacturer.

Cleaning and Maintenance:

Under no circumstances should the unit be serviced by any unqualified person(s). Any work to the steel frame, hydraulic Auto-Belay, or cable/roping should be performed by an experienced person in the field of service who is certified, bonded, etc., to perform the work. It is the owners' responsibility to ask for such certification and/or bonding verification.

Cleaning of the unit should be similar to an automobile (i.e., car wash with spray washers and mild detergents). Any person(s) who work on the Auto-Belay and are not authorized and/or not trained by Spectrum Sports Intl, will take 100% responsibility and liability on the product.

Limitation of Remedy:

During the period of warranty, Spectrum Sports Intl will do everything we can to answer and resolve any questions or concerns on the products we sell. Spectrum Sports Intl has the right to evaluate if a product is under warranty. To obtain repair or replacement parts, call or fax Spectrum Sports Intl Customer Service for a return authorization number. Include the following information: name, address, date of purchase, address where product is located, office phone or mobile phone (if at an event), and your product model and serial number. At your expense, ship or deliver the product to Spectrum Sports Intl: 324 W 2500 N Bldg. A, North Logan, UT. 84341. Replaced or repaired items will be shipped back to you at no cost and will be shipped in the same manner as it was received (i.e., overnight, ground, etc.). For items that must be received before the defective part is sent to Spectrum Sports Intl it is REQUIRED that a valid credit card be charged for the warranty item before Spectrum Sports Intl will ship. Once Spectrum Sports Intl receives the old part, a credit will be issued back to the credit card.

Waiver & Release from Liability

NOTICE: BY ACCEPTING YOUR _____, YOU ARE ACKNOWLEDGING THAT YOU HAVE READ, UNDERSTOOD AND ACCEPTED THE TERMS AND CONDITIONS STATED IN THIS MANUAL. YOU FURTHER ACKNOWLEDGE AND AGREE THAT YOU ARE WAIVING YOUR RIGHTS TO SUE OR BRING A COURT ACTION TO RECOVER COMPENSATION OR OBTAIN ANY OTHER REMEDY FOR ANY INJURY TO YOURSELF OR YOUR PROPERTY.

This Release, Waiver and Assumption of Risk (“Agreement”) entered into by and between the owner/operator, on behalf of his/her/its heirs, legal representatives, personal representatives, attorneys, affiliates, administrators, successors and assigns (“Releasor”) and in favor of KBG International, Inc. a Utah corporation doing business as Spectrum Sports Intl, its past, present and future officers, directors, stockholders, attorneys, agents, servants, representatives, employees, subsidiaries, affiliates, partners, insurers, predecessors and successors in interest, indemnitors, assigns and other related or affiliated entities or persons (“Releasee”), desires to operate a _____ and any other recreational activities associated therewith (the “Activities”). In consideration for Spectrum Sports Intl providing maintenance or service to my equipment or permitting me to purchase and/or otherwise operate and engage in these Activities, I have agreed to execute this Acknowledgment, Waiver & Release and further, more particularly, agree as follows:

ACKNOWLEDGEMENT: I acknowledge and am thoroughly aware that there are significant inherent risks and hazards associated with the Activities and all other outdoor recreational activities or being a spectator of these Activities. **I FULLY ACKNOWLEDGE AND UNDERSTAND THAT PARTICIPATION IN THESE ACTIVITIES CONTAINS INHERENT RISKS THAT MAY BE UNKNOWN OR UNANTICIPATED THAT MAY RESULT IN PHYSICAL OR EMOTIONAL INJURY INCLUDING BUT NOT LIMITED TO PARALYSIS, PERMANENT INJURY OR DEATH AND DAMAGE TO PROPERTY OR TO OTHER THIRD PARTIES.**

I further acknowledge that the nature and extent of the risks and hazards inherent in the Activities and my pursuit of these activities include or operating equipment associated with the Activities, but are not limited to:

1. Severe bodily injury or death resulting from the Activities and equipment utilized in connection with the Activities.
2. Severe bodily injury or death resulting from equipment failure and/or malfunction of my own or others’ equipment, including, but not limited to, failures of ropes, slings, climbing harnesses, bolts, bolt hangers, fixed anchor points.
3. Severe bodily injury or death resulting from falling climbers/participants or falling or dropped items, including, but not limited to, ropes, climbing hardware or other debris.
4. Severe bodily injury or death from improperly placed or faulty climbing protection, improperly tied knots, improperly buckled harnesses, or improper rope/cable, belay, rope/cable ascending or rope/cable descending techniques.
5. Severe bodily injury or death resulting from operator or participants own negligence or the negligence of others including other climbers, operators, participants, spectators, or users.
6. Severe bodily injury or death resulting from personal physical and mental limitations, including, but not limited to, fatigue, chill and/or dizziness, personal strength, coordination, sense of balance, which may diminish reaction time and increase risks of accident and ability to follow or give directions while climbing, lifting, spotting or being a spectator.
7. Severe bodily injury or death resulting from hazardous terrain or adverse weather conditions, including wind, rain, snow, hail, or sleet.
8. Severe bodily injury or death resulting from not following proper and customary personal safety procedures including procedures outlined in the owner’s manual for the equipment

9. Severe bodily injury or death resulting from not having qualified personnel maintain or service the equipment and/or not properly inspecting the equipment in accordance with the owner's manual.

I acknowledge that the above list of severe bodily injuries, dangers, hazards, and risks are described by way of example only, and are not inclusive of all possible risks associated with the Activities, and that other unknown and unanticipated risks may result in bodily injury, illness, or death. **I VOLUNTARILY ASSUME ALL SUCH RISKS WITH FULL KNOWLEDGE AND APPRECIATION OF THE DANGERS AND RISKS INVOLVED.**

RELEASE ASSUMPTION OF RISK AND RESPONSIBILITY: In consideration of my being allowed to participate and operate the equipment to conduct the Activities, and in recognition of the inherent risks of the Activities, I knowingly and intentionally agree on behalf of myself, my/our heirs, representatives, successors, officers, directors, stockholders, employees, executors, administrators, assigns, and anyone claiming interest through me, or on my behalf hereby **KNOWINGLY, INTENTIONALLY, AND VOLUNTARILY, RELEASE, WAIVE, DISCHARGE, HOLD HARMLESS AND AGREE NOT TO SUE** Releasees in or from any and all actions, suits, claims damages and liability (**INCLUDING ATTORNEY FEES OR COSTS**) or demands, obligations and/or causes of action of any nature whatsoever which I/we or, my heirs, representatives, successors, officers, directors, stockholders, employees, executors, customers, participants, administrators, assigns, and anyone claiming interest through me or my customers/participants may have against Releasees on account of any personal injury, property damage, death or accident of any kind arising out of or in any way connected with my operation of any equipment or anyone's participation in the Activities. I agree to indemnify and hold harmless Releasees from any and all liabilities or claims made by other individuals or entities as a result of my operation of or participation in the Activities. This release shall be effective even though said loss, damage, injury, paralysis, loss, or death results or has resulted from negligence, wrongful acts, omissions, breach of warranty or strict tort liability of Releasees (whether as the manufacturer or servicer of the equipment).

I further certify, acknowledge, and agree on behalf of myself (or the company listed above) that I am physically and mentally capable of participating in these Activities.

I assume responsibility for and voluntarily assume the risks for any personal injury, death and related expenses involved with these Activities.

I assume responsibility for damage to my/our person or property or the person or property of participants in the Activities.

I agree to indemnify and hold harmless Releasees for any and all claims, as well as all fees and costs. I further agree to indemnify and hold harmless Releasees for any and all claims for products they did not manufacture, maintain or service.

I also understand that Spectrum Sports Intl is not responsible for claims or allegations regarding any product manufactured or produced by other parties or entities.

I certify that I have adequate insurance to cover any injury or damage I may cause or suffer while operating or participating, or else I agree to bear the costs of such injury or damage to myself or my customers. I further agree to name Spectrum Sports Intl as an additional insured party on my liability

insurance policy with limits of not less than \$1,000,000 per occurrence and \$2,000,000 in the aggregate.

Agreement:

I understand how to operate the climbing product safely. This means that I do understand, but not necessarily limited to, how the Auto-Belay works on the climbing products, how to perform all of the required safety inspections, the rules, and in general manage crowd and staffing operational issues.

Acknowledgement:

I have carefully read this limited warranty, limited remedy, and release of liability and fully understand its contents. I am aware that this is a release of liability and a contract between me and Spectrum Sports Intl and its manufacturers, distributors, and retailers.

I understand that if I do not understand this warranty or understand the contents and accept the personal liability in the operations and the safety of the products, I will notify Spectrum Sports Intl in writing immediately. I also acknowledge that I will not operate the said products until I do so.

Limited Liability Warranty

Equipment manufactured by Spectrum Sports Intl, 324 W 2500 N Bldg. A, North Logan, UT. 84341, is warranted free from defect in material and workmanship for a period of 90 days from the date of purchase. Equipment not manufactured by Spectrum Sports Intl is covered to the extent of warranty provided by the original manufacturer and this warranty does not cover any equipment, new or used, purchased from anyone other than Spectrum Sports, Intl. All replacement parts shall be covered under warranty for a period of 90 days from date of purchase. SPECTRUM SPORTS, INTL MAKES NO OTHER REPRESENTATION OF WARRANTY OF ANY OTHER KIND, EXPRESSED OR IMPLIED, WITH RESPECT TO THE GOODS SOLD HEREUNDER, WHETHER AS TO MERCHANTABILITY, FITNESS FOR PURPOSE, OR OTHERWISE.

Spectrum Sports Intl sole obligation under this warranty shall be to repair or replace any part or parts which, to Spectrum Sports Intl satisfaction, prove to be defective upon prepaid return to Spectrum Sports Intl 324 W 2500 N Bldg. A, North Logan, UT. 84341. In such a case, once the necessary repair(s) has/have been made or a replacement part secured, Spectrum Sports Intl will pay the cost to return the item back to the customer. This obligation does not, however, include labor to install replacement parts, nor does it cover any failure due to accident, abuse, neglect, or use in disregard of instructions furnished by Spectrum Sports Intl. SPECTRUM SPORTS INTL SHALL NOT BE LIABLE FOR INCIDENTAL OR CONSEQUENTIAL DAMAGES WHATSOEVER.

All claims in regard to the parts or equipment must be made within two (2) days after Purchaser learns of the facts upon which the claim is based. Authorization must be obtained from Spectrum Sports Intl prior to returning any equipment, components, or parts. This warranty is voided by failure to comply with these notice requirements.

Production output is dependent on feed stock, input, and many other variables beyond the control of Spectrum Sports Intl; therefore, Spectrum Sports Intl makes no guarantees expressed or implied as to production performance.



Attention!

The warranty on Spectrum Sports Intl equipment remains valid only when genuine Spectrum Sports Intl replacement parts are employed. If anyone other than Spectrum Sports Intl authorized service technicians perform work or modify/repair any part of the product, it will VOID the warranty and any clause to our Liability. If purchaser defaults in making payment for any parts or equipment, this warranty shall be void and shall not apply to such parts and equipment. No late payment or cure of default in payment shall extend the warranty period provided herein.

Spectrum Sports Intl is not responsible for damage to any associated instruments, equipment or apparatus nor will Spectrum Sports Intl be held liable for loss of profit or other special damages for any reason. The Buyer, their employees, agents, and successors in interest assume all risks and liabilities for the operation, use and/or misuse of the product(s) described herein and agree to indemnify, hold harmless, and defend the seller from any and all claims and actions arising from any cause whatsoever, including sellers' negligence for personal injury incurred in connection with the use of said product(s) and any and all damages proximately resulting therefore.



Warning!

Only technically qualified individuals who have fully *read and understand* the provided instructions should operate the equipment. The equipment should be operated only in accordance with these instructions. The operator should follow all of the warnings and cautions set forth in the manual and the operator should follow and employ all applicable standard laboratory safety procedures.

8.2 Conclusion

This owner/operator manual has been written to assist in the proper installation and operation of the Stationary Climbing Towers & the AUTO-BELAY SAFETY SYSTEM. Spectrum Sports Intl has tried in its best effort to address relative issues; however, there will be additional information learned or situations that occur that we are unaware of at this time. Please, do not hesitate to call with any technical questions. Remember, there may be questions, issues and/or concerns that may arise through the use of this product that are not listed or addressed in this manual, please keep us informed. It is the responsibility of the owner/operator of this product to contact Spectrum Sports Intl if any questions arise. As with any amusement/safety device, physical harm may occur, and operators and participants must realize that this product is a physical activity, and that proper care should be taken to ensure safety. Please exercise good common sense and judgment while operating the Climbing Tower & AUTO-BELAY SAFETY SYSTEM.



Warning!

It is the customer's sole responsibility to clarify any question or concern with Spectrum Sports Intl before use and/or operation.

8.3 Entertainment Tips

Never forget that your Climbing Tower is a fun attraction and will draw attention. Use this unique feature to book company picnics, birthday parties, corporate promotion events, special events, public attractions, fairs, and festivals, to name a few. Never forget that the tower can be equipped for corporate advertising, generating revenue up and above the charge by the climb revenue. The belay coach (Climb Master) should be someone who enjoys people and has a positive rapport with people, making your attraction fun for the entire family. Remember that this tower was not necessarily designed for professional climbers. Route the product for the intended market – those who have always wanted to give rock climbing a try. The Climbing Wall is a product designed for fun!

9. TROUBLESHOOTING

This section is the troubleshooting guide for the AUTO-BELAY SAFETY SYSTEM. The common problems and solutions associated with this product are listed below.

Problem 1: The Auto-Belay cable will not retract

Check the air pressure in the tank.

- If there is NO air pressure: Charge tank to the appropriate psi and then check for air leaks by using soapy water.
- If there is air pressure: Check cable routing to ensure there is no cable obstructions.
- Check pulleys and the pulley cart to ensure the pulleys are turning freely and that the cable pulley cart is free from obstructions. Ensure the ram alignment is true.

With proper air pressure, does the tracking pulley cart seem to stop at a point and not track?

- If NO, call Spectrum Sports Intl – 888.563.0163
- If YES, check bearing for proper turning/tightness or if track is clear of debris.

Problem 2: There is grinding or loud rubbing noise

Cable is rubbing somewhere. Determine where the cable is rubbing and call Spectrum Sports Intl for directions.

Problem 3: Hydraulic oil is leaking. Hydraulic oil shoots out when a climber descends:

Locate the source of the leak (i.e., shaft-end of cylinder, brass breather vent of cylinder, hydraulic hose, and/or fitting, or tank).

- If the origin is from the cylinder-end where chrome shaft goes in and out, then the seals are worn. Call Spectrum Sports Intl to order parts and installation instructions.
- If the origin is from the cylinder-end with brass colored breather vent, please note that small amounts are normal for the purpose of lubricating the sliding cylinder head. However, large amounts can mean a torn seal, excessive wear, or some other abnormality. Please contact Spectrum Sports Intl for details.

Problem 4: AUTO-BELAY SAFETY SYSTEM will not hold air pressure?

With soapy water, check all fittings for proper seal, or air leaks.

- If air is leaking from fittings, tighten fitting, and check again. If problem continues, call for assistance.
- If air is leaking from air gauge or Schrader valve, tighten and re-check. If continues, call for assistance.

Problem 5: My air pressure is a little low. How do I add air to the unit?

On the side of the Auto-Belay Safety System, just below the pressure gauge, is a Schrader valve. This valve is similar to what you would see when you add air to tires on an automobile. Simply add air to this unit in the same manner you would to a car tire. Using an air chuck that is connected to an external air source, add air until the gauge reads between the ranges specified for the unit.

Problem 6: The oil level is no longer registering in the sight glass. How do I add oil?

- Step 1. Make sure the air pressure is let out of the tank.
- Step 2. Remove the cap at the very top of the tank with a 7/8" socket or wrench.
- Step 3. Use a funnel to add the oil (see manual for oil specs).
- Step 4. You should add one quart of oil after the oil becomes visible in the sight glass.
- Step 5. Replace the cap at the top of the belay tank and add air pressure until the proper pressure is achieved.
- Step 6. Prime the Auto-Belay Safety System.

Problem 7: The Handholds are loose and spinning?

Use the Hex tool supplied (5/16") and tighten them until they are secure. Do not over tighten them, it may break the handhold. Routinely check all handholds for tightness.

*Should you encounter a problem not listed and need assistance, please call: Spectrum Sports Intl (888)563-0163

APPENDICES

APPENDIX A. FORMS

Contact:		Phone:		Fax:		Email:	
SHIP TO:				BILL TO:			
Payment Type: COD CC PO#				Name on CC:			
Shipping: Ground 2Day 3Day Overnight				Card Type:		Exp:	
Shipping Acct #:				Card #:		CVC:	
Item Description	Price	Qty	Total	Item Description	Price	Qty	Total
Belay Tank Weldment	\$1,290		\$	Auto-Belay Sticker	\$7.00		\$
Carriage Weldment	\$450.00		\$	Cable Replacement Sticker	Free		\$
Cylinder (Specify Serial #)	\$275.00		\$	Air Pressure Sticker	Free		\$
Belay Hose	\$130.00		\$	2" x 5/8" - 11nc Bolt	\$5.00		\$
Bottom Cylinder Spacer	\$3.00		\$	4.5" Pulley Bolt	\$6.00		\$
Cylinder Cart Spacer	\$3.00		\$	5" Pulley Bolt	\$7.00		\$
Cable Spacer	\$3.00		\$	6" Pulley Bolt	\$8.00		\$
Strainer	\$89.00		\$	7" Pulley Bolt	\$9.00		\$
Check Valve	\$240.00		\$	8" Pulley Bolt	\$10.00		\$
Sight Glass	\$15.00		\$	8 1/2" Auto-Zip Pulley Bolt	\$10.00		\$
Tee Fitting	\$85.00		\$	3 1/2" Auto-Zip Pulley Bolt	\$5.00		\$
Sealed Bearing	\$5.00		\$	Nylock Nut 3/4	\$2.00		\$
Shrader Valve	\$10.00		\$	Nylock Nut 5/8x11 (For bolts)	\$2.00		\$
Moisture-proof Breather	\$6.00		\$	Nylock Nut 1/4x20nc	\$1.00		\$
Pressure Gauge	\$30.00		\$	5/8" Lock Washer	\$1.00		\$
Pulley (6 inch)	\$22.00		\$	Pin Clip	\$1.00		\$
Swivel	\$62.00		\$	6" Cylinder Pin	\$12.00		\$
Carabineer (Trple Auto-Locking)	\$24.00		\$	Cylinder Pin	\$6.00		\$
Quick Link	\$6.00		\$	1539 & 1539-1 Seal Kits	\$45.00		\$
Flow Control	\$54.00		\$	2039 2" Zip Seal Kit	\$45.00		\$
Flow Control Elbow	\$6.00		\$	Sweeco Seal kit (One Seal)	\$12.00		\$
Auto-Zip Pulley	\$69.00		\$	Lin Act Seal Kit	\$30.00		\$
Owner's Manual	\$25.00		\$	Lin Act Gland Kit	\$85.00		\$
Oil Containment System	\$35.00		\$	Inspection Rope			\$
			\$				\$
			\$				\$
			\$				\$
			\$				\$
			\$				\$
			\$				\$
Certified Cable w/ both ends crimped: 24' - \$215.00; 32' - \$260.00; Zip \$395.00 (uncertified: \$230.00)							
Specify Length _____							\$
Extreme Engineering Cables: 24' - \$295.00; 32' - \$325.00							
Specify Length _____							\$
Cost of Goods		\$		Shipping & Handling		\$	
Discount		\$		COD Charge (\$15)		\$	
UT Sales Tax (6.37%)		\$		Total Due:		\$	
SPECTRUM				3785 N. Hwy. 91 ~ Hyde Park, UT 84318			
SPORTS INTL				PH: 888.563.0163 ~ FX: 435.792.3884			

* Prices are subject to change, please call and get the most updated pricing for any parts that you may need.

Figure 5. Auto-Belay/Zip Accessories & Parts Order Form

Climbing Wall Parts Order Form

COMPANY:				SHIPTO:			
CONTACT:							
PHONE:							
EMAIL:							
Payment: <i>Credit Card / POA / Warranty / Wire / Net 30</i>				BILLTO:			
Shipping: <i>Ground / 2-Day / 3-Day / Overnight / DHL</i>							
HANDHOLDS, BUZZERS, CLIMBING SURFACE				HARNESSES			
PART #	Item Description	Price	Qty	PART #	Item Description	Price	Qty
HP 1015	L/Beginner Handhold & Bolt (Color)	\$15		HLR 1007	Quick Harness	\$145	
HP 1016	M/Intermediate Handhold & Bolt (Color)	\$13		HLR 1015	Child Harness	\$60	
HP 1017	S/Advanced Handhold & Bolt (Color)	\$10		TRAILER PARTS			
PA 1006	T Handle (Handhold Wrench)	\$19		PART #	Item Description	Price	Qty
PA 1042	T Nuts	\$4		PA 1070	2 Button Remote (Hydraulic Lift) 4 Pin	\$225	
EL 1017	Red Buzzer Button Cap	\$12		PA 1071	4 Button Remote (Hydraulic Lift) 6 Pin	\$300	
EL 1016	Buzzer Electronics & Button	\$80		EL 1010	Remote Cord 4 Pin (For 2-Button Remote)	\$62	
HP 1018	Buzzer Housing & Bolt	\$21		EL 1011	Remote Cord 6 Pin (For 4-Button Remote)	\$100	
EL 1018	Buzzer Extra Contact	\$20		EL 1012	4 Pin Receptacle w/ Wires (2-btn remote)	\$84	
PA 1001	Horn/Siren	\$60		EL 1013	6 Pin Receptacle w/ Wires (4-btn remote)	\$105	
FJ 1027	Fiberglass Repair Kit	\$40		SSJ 1033	7,000/8,000 lb Jack	\$175	
AUTO-BELAY PARTS				JC 1001	7,000/8,000 lb Jack Gear Kit	\$25	
PART #	Item Description	Price	Qty	JC 1002	7,000/8,000 lb Jack Handle Kit	\$30	
SE 1001	1539 Seal Kit	\$45		JC 1004	Jack Drop Leg Pin (7,000/8,000 lb)	\$14	
SE 1002	1539-1 Seal Kit	\$45		SSJ 1031	10,000 lb Jack (MZL)	\$240	
SE 1006	1539 Piston Seal (2 Per Piston)	\$30		SSJ 1032	10,000 lb Jack (32" Wall)	\$240	
SE 1005	1539-1 Piston Seal (1 Per Piston)	\$15		JC 1005	10,000 lb Jack Gear & Handle Kit	\$80	
SE 1010	1539-3D (1 O ring only)	\$15		JC 1003	Jack Drop Leg Pin (10,000 lb)	\$14	
SE 1004	1539-1 Glide Ring	\$15		HA 1177	Jack Extension Tube Pin	\$7	
SE 1007	Sweco Piston Seal (One Seal)	\$12		EL 1014	Receptacle Closure Cap	\$25	
SE 1009	Lin Act Seal Kit	\$30		EL 1029	Battery (12v Deep Cycle)	\$120	
SE 1008	Lin Act Gland Kit	\$85		EL 1019	Battery Box w/ Lid	\$25	
HY 1031	.065 Check Valve (For AB32)	\$50		EL 1048	7 Pin Trailer Harness	\$39	
HY 1068	.040 Check Valve (For AB40 & AB75)	\$50		EL 1038	7 Pin Junction Box	\$20	
SSJ AB32	Gen 5 Auto Belay Full System	\$2,800		SUPPORT MATERIALS & UPGRADES			
HY 1102	GEN 5 Displacement Cylinder	\$355		PART #	Item Description	Price	Qty
HY 1106	Retrofit Hose Kit For GEN 5 Cylinder	\$125		Misc	Owner's Manual	\$25	
HY 1047	1539-3 SSI Auto Belay Cylinder (Specify SN)	\$275		BSG 1028	Warning Sign	\$25	
HY 1056	EE Auto-Belay Cylinder	\$315		BSG 1025	Rules Sign for Climbing Wall	\$25	
HY 1045	Oil Eye	\$10		PA 1045	Klime Walk Storage Cover	\$985	
HY 1046	Breather Cap	\$10		PA 1043	24 ft Climbing Wall Storage Cover	\$810	
HY 1069	Breather Cap & Elbow	\$14		PA 1093	32 ft Climbing Wall Storage Cover	\$910	
HY 1059	Breather Cap (old)	\$6		PA 1061	Padded Jack Covers (each)	\$45	
HY 1024	Auto Belay Pressure Gauge	\$30		HY 1011	Schrader Valve	\$10	
SSJ 1025	Cable Guide (Left or Right)	\$45		PA 1060	Auto Belay Gate (Black)	\$40	
SSJ OIL	Oil Containment System	\$50		Needs More Information from Customer			
SSJ 1026	Cable Guide Roller	\$5		PART #	Item Description	Price	Qty
WA CART	Pulley Cart	\$100		JC 1020	Swivel Jack (specify wall type)	\$90	
PA 1003	Pulley Cart Bearing	\$5		HY	Hydraulic Lifting Cylinder	\$245	
PA 1011	Pulley (6 inch)	\$22		HY	Single Valve Hydraulic Lift Pump	\$1,050	
HA 1035	4.5" Pulley Bolt	\$6		HY	Dual Valve Hydraulic Lift Pump	\$1,250	
HA 1036	5" Pulley Bolt	\$7			Banner Hardware Kit (2 rods)	\$250	
HA 1037	6" Pulley Bolt	\$8		EL - Timer	Timer System	\$1,100	
HA 1038	7" Pulley Bolt	\$9			Flag Mounting Kit	\$35	
HA 1050	Nylock Nut 5/8x11 (For bolts)	\$2		BSG 1055	Vinyl "Closed" Sign	\$450	
PA 1058	Swivel	\$62			Foam Landing Pad	\$520	
PA 1012	Carabiner (3 Auto-Locking) (Gold)	\$24		PA 1092	Red Strap Tie Down	\$32	
HA 1183	Quicklink	\$6		HA 1140	Hitch Pin	\$6	
CABLE BEC Up to 100' Spectrum Cert. Cable		\$265		HY 1040	Solenoid	\$55	
CABLE BEC Over 100' Spectrum Cert. Cable		\$315					
CABLE BEC Greater Than 130' Spectrum Cert. Cable		\$330					
CABLE BEC Greater Than 150' Spectrum Cert. Cable		\$355					
CABLE BEC Up to 100' EE Cable		\$265					
CABLE BEC Over 100' EE Cable		\$315					
Cable Lengths:				Spool #:			
SPECTRUM SPORTS INTL				Pulled By:			
				Serial Numbers:			
				Box Weight:			

Figure 6. Climbing Tower Accessories & Parts Order Form

APPENDIX B. CHANGING AN AUTO-BELAY CYLINDER



Attention!

This procedure is for the Generation 4 Auto-Belay Safety System design with 4" x 4" tank installed on climbing structure. Two people are recommended for use.

Tools Required:

- Two adjustable wrenches capable to open to 1 ½" or two - 1 1/2" and one 1 1/8" open end wrenches
- Air chuck
- 7/8" open end wrench
- 9/16" open wrench
- ISO 32 oil; the following name brand fluid is available:
 - Mobil: DTE - 24, Texaco: RANDO - 32, and Chevron AW - 32
- Rags to absorb oil

Directions:

1. Pull cable/rope all the way down to bottom of wall panel to fully retract cylinders (3) to force oil from the cylinder tube.
2. Depressurize the Auto-Belay tank (1) **entirely**. Depress the center of the Schrader valve (15) with a Schrader valve air chuck.
3. Use the wrench to remove 1" nut (5) from 1" bolt (7). Remove 1" bolt (7) on bottom pulley bracket. Keep the spacer (20) from between cylinders on 32' Auto-Belays to put it back on later.
4. Remove breather (18) from old cylinder and install it on the new cylinder.
5. Use the wrench to remove hose (11) and check valve (20) from cylinder that you are replacing. Loosen hose fitting then check valve (20), repeat this until the check valve is removed.
6. Now it takes two people, one person to hold a CLEAN rag over the check valve (20) to keep oil from escaping. Oil can be replaced afterwards. The second person can do the next steps while the other person holds a rag over the check valve.
7. At the top of cylinder (rod end) remove bottom clip from the pin so the pin may be pulled out. Keep any spacer (19) to reinstall as you put a new cylinder on.
8. The cylinder may now be removed.
9. Work backwards from here repeat steps 3-5 to attach new cylinder.
10. Once everything is in place add air to the Auto-Belay tank until the pressure gauge reads 90 psi. The procedure is the same for 24' and 32' walls.
11. Purge the air out of cylinders by repeatedly pulling the rope down and then allow it to rise by hand until resistance is felt throughout the entire down stroke. Now check oil level.
12. If oil needs to be added to make oil visible in oil lens, repeat step 2. Remove fill plug at top of tank with a 7/8" wrench or a 5/16" Allen wrench. Add oil, then tighten fill plug and repeat step 9. Check oil level again. Repeat if necessary to assure that oil level is in the middle of sight gauge/oil eye.

APPENDIX C. OIL COLLECTION KIT INSTALLATION

You will need an adjustable wrench to complete this installation.

1. Remove the old breather from the cylinder. It will be installed later.
2. Thread in the tee fitting and tighten until the fitting is parallel to the belay cylinder (see the figure below).
3. Thread and tighten the breather into top of the tee fitting.
4. Thread and tighten the barb fitting into the bottom of the tee fitting.
5. Push one end of the clear tube on the barb fitting.
6. Measure 10 ½" down from the tee fitting to the top of the bottle cage and attach with two zip ties. Make sure the ties cross over the mounting plate of the cage before tightening the zip ties.
7. Place the other end of the clear tube into the opening of the bottle.
8. Make a note of the oil level by checking it frequently to determine if repairs are needed to belay cylinders. For example, if you notice some oil in the bottle, write the date on the bottle at the oil level so you can monitor it from then on. If you have any questions concerning the oil you see in the bottle, contact Spectrum Sports Intl.

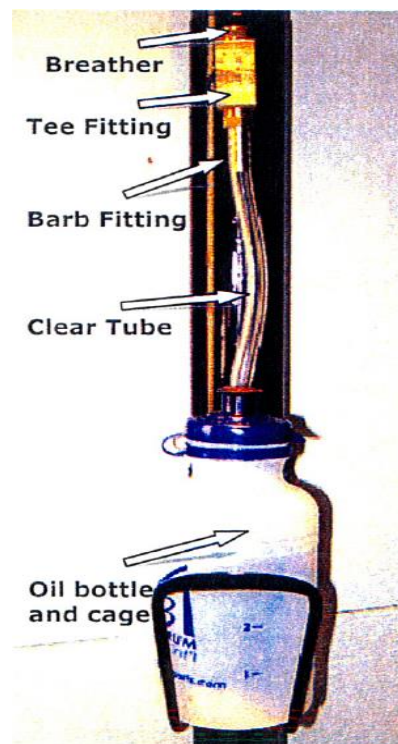

Figure 7. Oil Collection Kit Installation

APPENDIX D. SEAL KIT REPLACEMENT

Occasionally the seals in the Auto-Belay Cylinders will have to be replaced. The most common problem found with leaky cylinders is found on the piston side of the rod. Typically, if this problem is found early and fixed before excessive use, the other seals will stay in good working condition. Thus, it is important to monitor all belays on a daily basis. Oil Containment Kits are a cheap and effective way to monitor and contain oil leakage. Oil kept clean can be reused in the belay.

Tools:

- 1 ½" Spanner wrench with 1/8" teeth (or a pair of channel locks)
- Small flat blade screwdrivers
- Small pick
- Clean rags

NOTE: All work on cylinders should be done in a clean and contaminant free area.

Directions:

1. Start by taking off the head of the cylinder. If you do not have a spanner wrench, then a pair of channel locks will do the job. After unscrewing the head, carefully pull it out making sure not to excessively drag the seals on the threads. Remove the entire rod.
2. Carefully remove the seal on the piston side of the rod. Taking note of the seal placement, use a pick to pry up the seal while the screwdriver circles the perimeter of the piston, lifting the seal to the ridge as it goes.
3. Remove the wear ring.

PICTURE 1

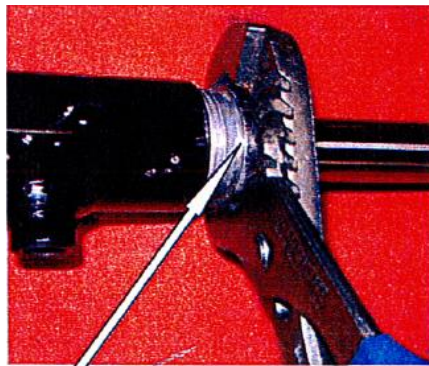

This image displays the "Head."

PICTURE 2

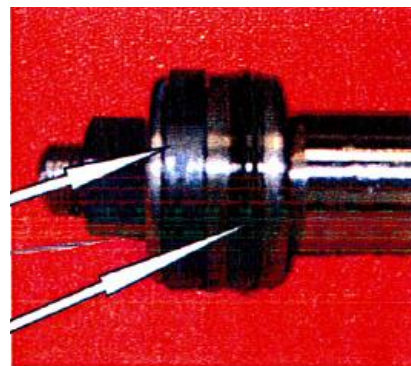

This image displays the "Wear Ring" (left) and the "Crown Seal" (right).

Figure 8. Seal Kit Replacement Images

4. Clean and lube the seals and head with ISO 32 oil. Replace the “Wear Ring” with a new one. Gently and slowly walk the “Crown Seal” up the piston end until it falls into place. Make sure it sits properly.

NOTE: In many cases (if caught early), this is the only seal you will have to replace. If the other seals need to be replaced, do so in the same manner. Take note of seal placement and make sure everything is clean and well lubed. More tools may be necessary if you choose to replace all seals.

APPENDIX E. CABLE REPLACEMENT (BOTH ENDS TERMINATED)



Warning!

Spectrum Sports Intl cannot be held liable for injuries sustained from changing out cable(s). The customer will have to use their better judgment and have the ability to perform this task safely. Two people are recommended for changing out cables.

Tools:

- Two 15/16" open-end wrenches or two adjustable wrenches
- Two 7/16" open-end wrenches
- Air chuck
- One 5/8" open-end wrench
- Replacement cable
- 6' ladder if changing one of the middle routes
- 30-40 minutes per cable change out

Directions:

1. To change cable(s) let all of the air pressure out of the Auto-Belay tank. To depressurize the Auto-Belay(s), attach an air chuck onto Schrader valve (#15). Pull the cable with the red hose towards the bottom of the climbing tower so that the cylinders are compressed completely. This will put the pulley cart (#2) closer to the bottom pulleys.
2. Make note of which side the cable enters the Auto-Belay pulley cart and the side it terminates to. Also make a note of how the cable is routed from pulley-to-pulley. Use a piece of tape to mark each side of the pulley cart.
3. Use the 5/8" open-end wrenches to open the quick link so the cable end can be removed. The quick link can remain attached to the pulley cart (#2).
4. If the cable end does not fit between the pulleys and the top of the Auto-Belay tank, the pulley assemblies have to be disassembled. Start by removing the 1/4" nuts from the 1/4" bolts (#8) with the 7/16 wrench from the pulley cart and the bottom pulley assembly. Keep hardware and spacers (#10) together.
5. Now remove the 5/8" nut from the 5/8" bolt (#9) using 15/16 wrenches or adjustable wrenches, from pulley cart and bottom pulley assembly. Take care not to lose the spacers #3, #4, and #5 while removing all pulleys.
6. Now use the 15/16 wrenches to loosen the 5/8" nut from the 5/8" bolt of the bottom pulley on the davit at the top of the wall, enough to remove cable. The upper pulley on the davit will

need to be removed entirely to remove cable. A stepladder may be required if you are replacing a cable on a middle route. Once the top pulley is removed, you can then remove the old cable entirely.

NOTE: When replacing the cable, take care not to kink or pinch cable by pulling on it when there is a loop in the cable.

7. Lay the new cable out on the ground first, to remove loops and have the red hose at the bottom of the wall.
8. Start feeding the end of the cable through the top pulley mount on the davit and then place pulleys groove on the cable and finish remounting the pulley. Do the same to the second pulley on the davit. Tighten the 5/8" nuts to 5/8" bolts.
9. Now pull enough cable to reach the pulley cart. Make sure the cable doesn't go underneath or behind a steel wall support while doing this.
10. **This is where two people are required.** Have a cable enter the pulley cart (the side that is marked with tape). Pull the cable to bottom pulley area, place the cable on a pulley and start 5/8" bolt through the side plate. Place the correct spacer (#4) on the 5/8" bolt; put pulley with cable on the bolt. Pull the cable towards the pulley cart. Start the 5/8" bolt, place spacer (#5) on bolt, place the cable on the pulley, place the pulley on the bolt. Repeat these steps using the correct spacers until cable ends at the quick link. Place and tighten 5/8" nuts onto 5/8" bolts. Replace all 1/4" bolts (#7) and 1/4" nuts and spacers (#6), to keep cable on pulleys. Refer closely to the assembly diagram below.
11. Make sure you attach terminated cable end onto the quick link and tighten the quick link with a wrench.
12. Reattach carabiner, swivel, and quick link to cable with the red hose that is on the outside of the climbing wall. Attach the carabiner to the wall.
13. You now can re-pressurize the Auto-Belay to the recommended air pressure. Add air slowly to the Auto-Belay tank so that the cylinders don't rapidly extend and cause the cable to jam in a pulley.

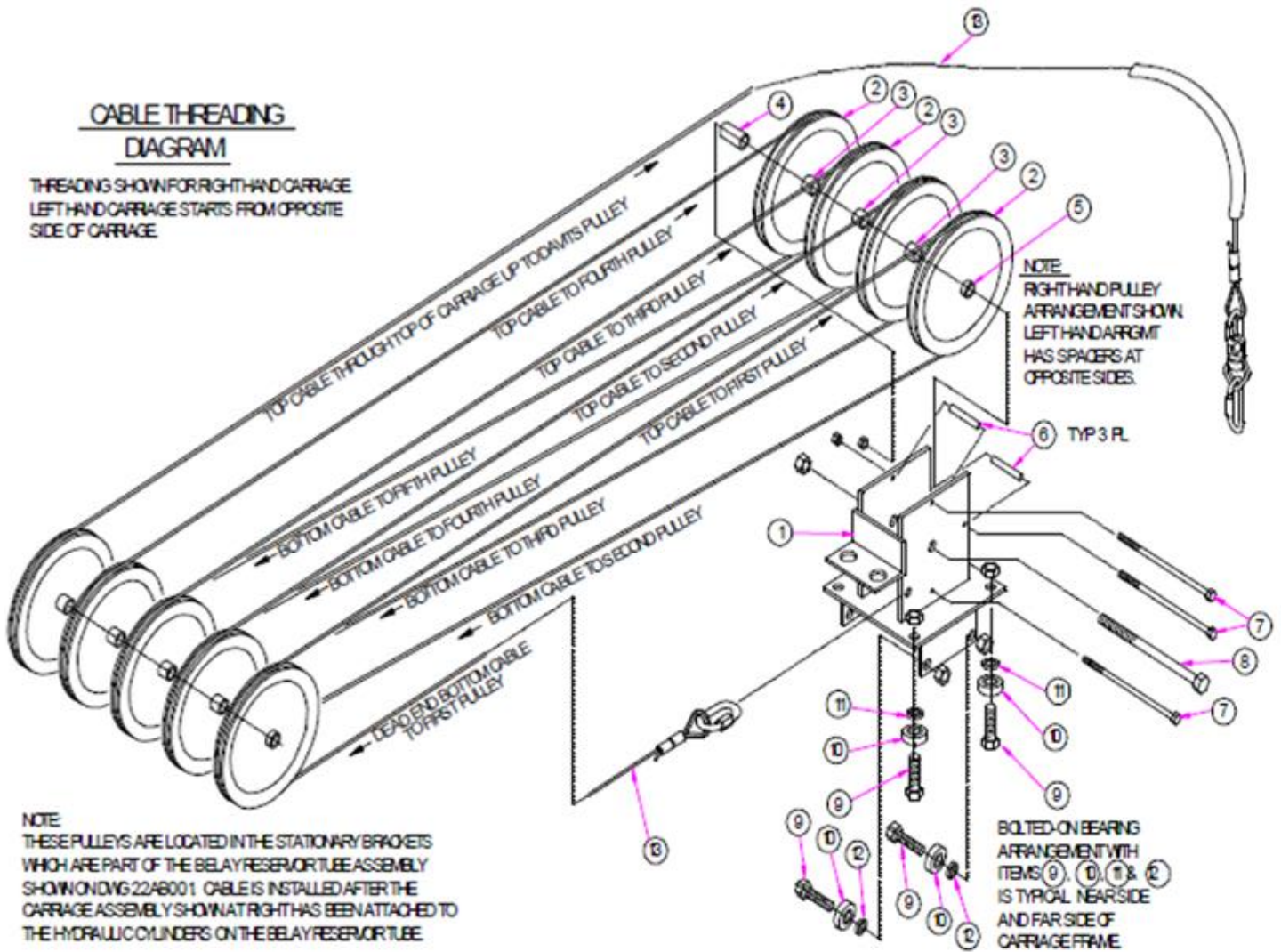
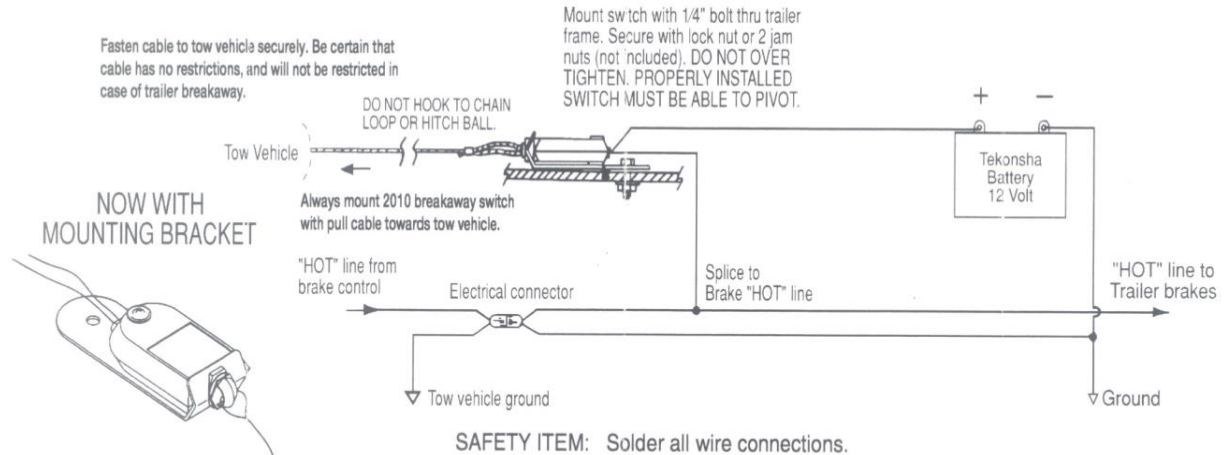

Figure 9. Cable Threading Diagram

APPENDIX F. WIRING

SCHEMATIC WIRING DIAGRAM FOR TEKONSHA 2010 BREAKAWAY SWITCH



ATTENTION INSTALLER: Please give this sheet to consumer upon completion of installation.

1. Mount Tekonsha battery case securely to frame, jack post or other suitable location on trailer.
2. Bolt breakaway switch bracket to frame of trailer or battery case bracket using 1/4" bolt and lock nut or (2) 1/4" jam nuts. (Bolt and nuts not included in kit).
CAUTION: Do not overtighten bolt. Switch must be able to pivot.
3. Check and install battery.
4. Wire per schematic diagram. Properly insulate all connections.
5. Attaching to tow vehicle:
Attach cable to tow vehicle frame being certain no strain is placed on cable.
CAUTION: Do not hook cable to safety chain loop or hitch ball.
CAUTION:
 1. Switch location should be selected to insure unobstructed line of pull in event of vehicle separation.
 2. Do not let cable drag on ground.
 3. Check condition of battery prior to each trip.
 4. **WARNING: Disconnect trailer plug before testing breakaway unit. Failure to do so will result in severe damage to electronic brake control.**























Tekonsha[®]

ENGINEERING COMPANY 537 N. CHURCH STREET, TEKONSHA, MICHIGAN 49092 Phone: (517) 767-4142

Rev. E 0698
p/n 538

Figure 10. Breakaway Switch Wiring Schematic

TAP™	6-WAY MOLDED CABLES			7-WAY MOLDED CABLES		
	Function	Gauge	Location*	Function	Gauge	Location*
 yellow	Left Turn / Brake	14		Auxiliary Power	14	
 green	Right Turn / Brake	14		Tail / Marker Light	14	
 brown	Tail / Marker Light	14		Right Turn / Brake	14	
 white	Ground	14		Ground	10	
 black	Auxiliary Power	14		Battery	10	
 red	Electric Brakes	14		Left Turn & Brake	14	
 blue				Electric Brakes	12	

*Locations are given looking at the FRONT of the plug.

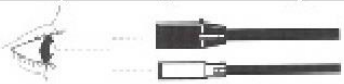

Figure 11. TAP Molded Cables (Wiring)

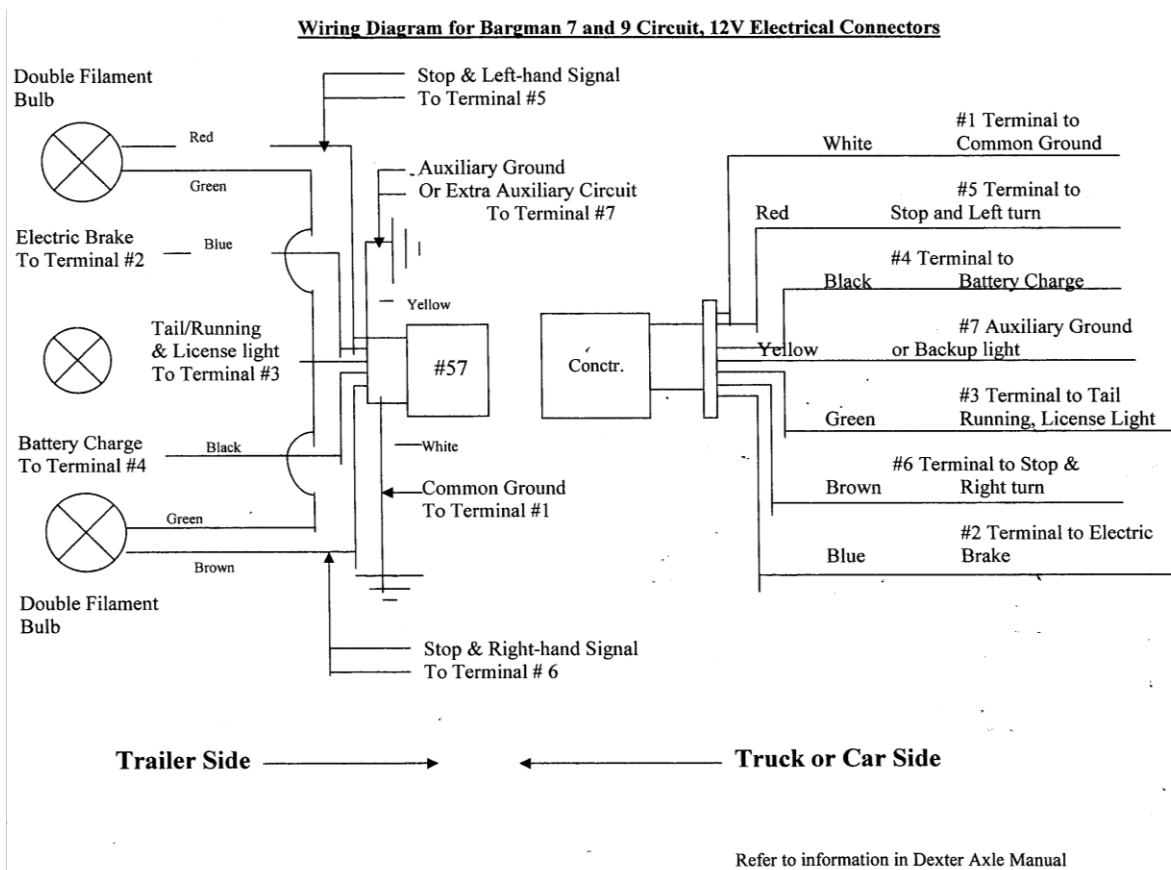

Figure 12. Wiring Diagram for Bargman 7 and 9 Circuit (12V Electrical Connectors)

APPENDIX G. ASTM F 1305



Designation: F 1305 – 94

Standard Guide for the Classification of Amusement Ride and Device Related Injuries and Illnesses¹

This standard is issued under the fixed designation F 1305; the number immediately following the designation indicates the year of original adoption or, in the case of revision, the year of last revision. A number in parentheses indicates the year of last reapproval. A superscript epsilon (ϵ) indicates an editorial change since the last revision or reapproval.

1. Scope

1.1 This guide provides a uniform procedure that should be used when classifying patron injury and illness data related to amusement rides and devices.

1.2 *This standard does not purport to address all of the safety concerns, if any, associated with its use. It is the responsibility of the user of this standard to establish appropriate safety and health practices and determine the applicability of regulatory limitations prior to use.*

2. Terminology

2.1 *Definitions of Terms Specific to This Standard:*

2.1.1 *illness*—personal discomfort resulting in treatment including a personal illness, food poisoning, drug abuse, toxic inhalation, insect sting, or other similar occurrence.

2.1.2 *injury*—sustained bodily harm resulting in treatment such as trauma, cuts, bruises, burns, and sprains.

2.1.3 *minor injuries/illnesses*—injuries and illnesses which may or may not require emergency first aid or significant treatment, or both, but cannot be otherwise classified as a serious injury or illness. This category includes incidents where treatment is limited to such things as the dispensation of over-the-counter medication or plastic adhesive strips², cleansing, rest, and other similar duties or assistance.

2.1.4 *serious injuries/illnesses*—a personal injury/illness that results in death, dismemberment, significant disfigurement, permanent loss of the use of a body organ, member, function, or system, a compound fracture, or other significant injury/illness that requires immediate admission and overnight hospitalization and observation by a licensed physician.

3. Significance and Use

3.1 The purpose of this guide is to provide a uniform procedure under which the amusement ride and device industry can organize data related to injuries and illnesses. This classification system may be used to formulate statistical information within the categories provided and will facilitate the analysis of

¹ This guide is under the jurisdiction of ASTM Committee F-24 on Amusement Rides and Devices and is the direct responsibility of Subcommittee F24.40 on Operations.

Current edition approved April 15, 1994. Published June 1994. Originally published as F 1305-90. Last previous edition F 1305-90.

² Band-Aid brand adhesive strips, a trademark of Johnson and Johnson Products, Inc., New Brunswick, NJ 08093, have been found suitable for this purpose.

injury and illness incidents. The classification system may assist owner/operators and manufacturers to review incidents directly related to their amusement rides and devices, and may provide information for alternatives to reduce or eliminate similar occurrences.

4. Recording Recommendations

4.1 The administration of emergency health care service and treatment should be recorded as deemed appropriate by the owner/operator of amusement rides and devices to include the documentation of all first-aid treatment, including minor injuries and illnesses, in a first-aid log. Injuries and illnesses other than minor should be reported on a firstaid incident report in accordance with 4.2.

4.2 *First-Aid Incident Report*—A first-aid incident report should be completed for injuries or illnesses that result in hospital admission or where medical treatment is given, recommended, or may be required at a future date. All injuries or illnesses reported and other than those classified as minor, can be presumed to be in this category.

4.3 *Recorded Information:*

4.3.1 Information recorded in the first-aid incident report should include but not be limited to the following, where applicable:

4.3.1.1 Date the incident occurred.

4.3.1.2 Name, address, and telephone number of the person to receive emergency health care service or treatment.

4.3.1.3 Age of the person to receive emergency health care service or treatment.

4.3.1.4 Manufacturer's name of the amusement ride or device where or on which the incident occurred.

4.3.1.5 Description of the injury or illness. Physical description of the injury or illness. Description of the events causing and related to the incident.

4.3.1.6 Description of the first-aid service or treatment administered including medications given.

4.3.1.7 Incident classification in accordance with Section 5.

4.3.1.8 Additional information deemed necessary by the owner/operator.

5. Classification of First-Aid Incidents

5.1 When recording an applicable first-aid-related incident the owner/operator of an amusement ride or device should classify the injury or illness in accordance with each of the

 **F 1305**

following categories based on the available reported or observed reliable information, or both:

5.1.1 *Amusement Ride and Device Incidents Classified in Accordance with Injury Qualification and Degree of Injury*—Injury, illness, serious injury/illness, and minor injury/illness as defined in Section 2 should be determined by the owner/operator to best describe the incident circumstances.

5.1.2 *Amusement Ride and Device Incidents Classified in Accordance with Facility Implication*:

5.1.2.1 *Facility-Related Incidents*—Injuries or illnesses that occur on facility premises shall be additionally classified as “Facility Related.”

5.1.2.2 *Not-Facility Related Incidents*—Injuries or illnesses that occur off facility premises shall be additionally classified as “Not Facility Related.”

5.1.3 *Amusement Ride and Device Incidents Classified in Accordance with Facility Location*:

5.1.3.1 *Amusement Ride and Device on Ride Incident*—Injuries or illnesses that actually occur to a person while riding during the operation of the amusement ride or device, including during the start up or shut down procedures, shall be additionally classified as an amusement ride and device “On Ride Incident.”

5.1.3.2 *Loading and Unloading Incidents*—Injuries or illnesses that actually occur to a person while he is within the area designated for loading and unloading of an amusement ride or device that was under the direct control of an amusement ride and device operator or attendant shall be additionally classified as a “Loading and Unloading Incident.”

5.1.3.3 *Queue Line Incident*—Injuries or illnesses that actually occur to a person while in a queue line for an amusement ride or device shall be additionally classified as a “Queue Line Incident.”

5.1.3.4 *Other Incidents*—Injuries or illnesses that occur to a person in a location other than as described in 5.1.3.1, 5.1.3.2, or 5.1.3.3 shall be classified as other than the preceding classifications and should be categorized in accordance with other predetermined descriptions that may be established by the owner/operator.

6. Manufacturer Notification

6.1 The owner/operator of an amusement ride or device shall notify the appropriate manufacturer(s) of an incident that resulted in a serious injury as defined in 2.1.4 within seven days of the occurrence of the incident.

The American Society for Testing and Materials takes no position respecting the validity of any patent rights asserted in connection with any item mentioned in this standard. Users of this standard are expressly advised that determination of the validity of any such patent rights, and the risk of infringement of such rights, are entirely their own responsibility.

This standard is subject to revision at any time by the responsible technical committee and must be reviewed every five years and if not revised, either reapproved or withdrawn. Your comments are invited either for revision of this standard or for additional standards and should be addressed to ASTM Headquarters. Your comments will receive careful consideration at a meeting of the responsible technical committee, which you may attend. If you feel that your comments have not received a fair hearing you should make your views known to the ASTM Committee on Standards, 100 Barr Harbor Drive, West Conshohocken, PA 19428.

This standard is copyrighted by ASTM, 100 Barr Harbor Drive, West Conshohocken, PA 19428-2959, United States. Individual reprints (single or multiple copies) of this standard may be obtained by contacting ASTM at the above address or at 610-832-9685 (phone), 610-832-9555 (fax), or service@astm.org (e-mail); or through the ASTM website (<http://www.astm.org>).

APPENDIX H. CLIMBING TOWER HORN DIAGRAM

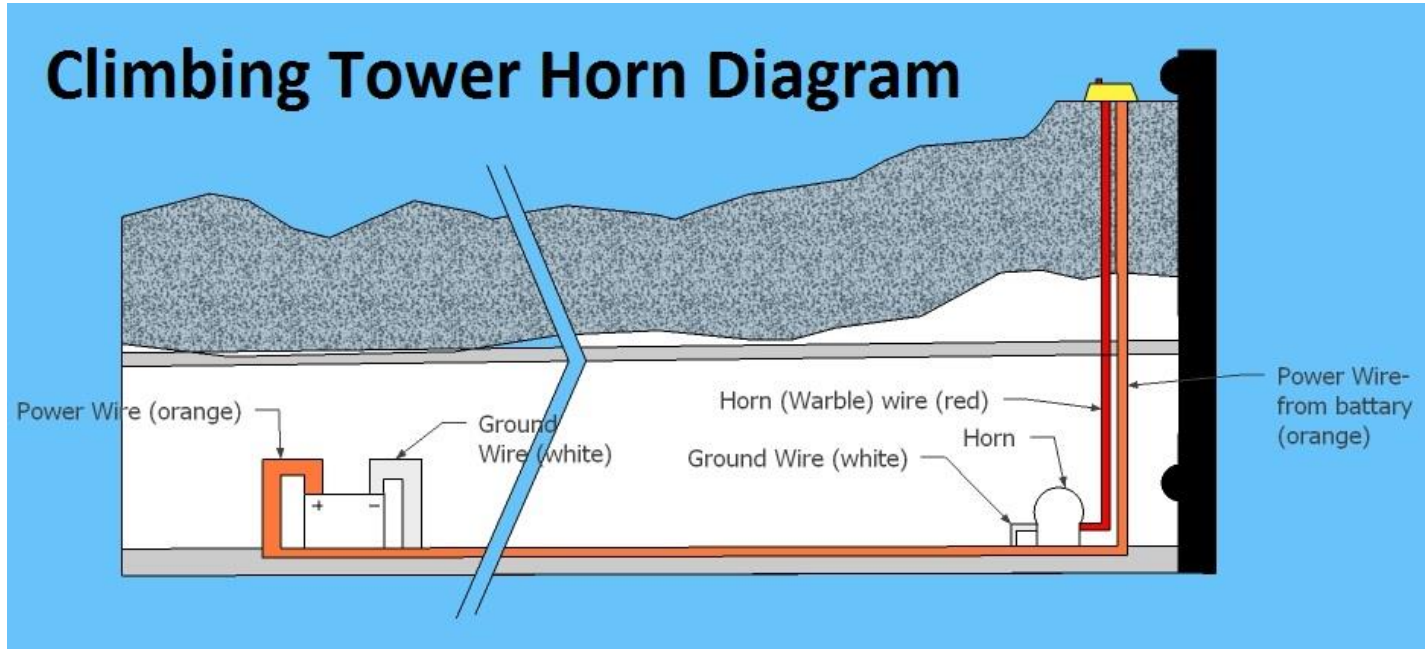

Figure 13. Climbing Tower Horn Diagram

APPENDIX I. SPECTRUM SPORTS INTL QUICK-HARNES

This appendix contains the instruction guide & warning information for the Spectrum Sports Intl Quick-Harness.



Attention!

WARNING: Read carefully before using this product. Before each use, check the condition of the webbing at the tie-in point of the adjustment buckles, and of the safety stitching. Check for cuts, wears, and damage caused by use (look for cut or torn threads). Check that the buckles operate correctly. If you have any questions, please contact Spectrum Sports Intl at 888-563-0163

*The harness described in this instruction guide exceeds the requirements set forth from ANSI Standard ANSI A10.14.1991, and UIAA standards.

USE: This product must only be used by competent and responsible persons, and those placed under the direct control of responsible person. To prolong the life of this product, care is necessary when transporting, and using it. Avoid impacts and rubbing against abrasive surfaces or sharp edges.

SAFETY: Do not hesitate to replace any product showing signs of wear which might affect its strength and restrict operation. For your safety, we advise you to adopt a 3-level checking schedule:

1. Before and after each use, it is necessary to check the condition of the product.
2. Before and after each use, it is important to inspect the entire product completely for wear and tear.
3. Weekly, a more thorough inspection must be carried out. For example:
 - a. Feeling and carefully inspecting all stitching.
 - b. Analyzing the buckles for proper engagement when closed.
 - c. Visually inspecting the inside of the attachment loops for wear. If the sheath is worn through, replace immediately.
 - d. Checking there is no fraying on the webbing.

For more safety and better control of your equipment, we advise you to keep an inspection record for each product.



Warning!

Do not continue to use this product after a major fall or impact of the product. Even though no external signs may be visible, a deformation may restrict its operation. Internal damage may have occurred, thus reducing its strength.

Harness Life: The useful life depends on the intensity of use. Also, the environmental elements will considerably accelerate wear: salt, sand, snow, ice, moisture, and chemicals. Maximum useful life for this Quick-Harness is five years.

GUARANTEE: This product is guaranteed for 1 year against any faults in materials or manufacture. Exclusions from the guarantee include: normal wear and tear, modifications, alterations, incorrect storage, poor maintenance, damage due to accidents, negligence, or improper usage.



Warning!

Spectrum Sports Intl is not responsible for the consequences or damages resulting from the use of this product. The purchaser assumes all risks and responsibilities for damages, or injury which may occur during incorrect use. If you are not able to assume this responsibility do not use this equipment.

The steps from the Spectrum Sports Intl Quick-Harness Brochure can be seen on the following page.



1. Have climber hold harness to their belly button.



2. Close harness waist buckle and tighten firmly by pulling on webbing end.



3. Make sure that the webbing end stays in the elastic loop.



4. Have climber pull red webbing between/around their leg.



5. Close the buckle securely.



6. Tighten firmly by pulling on the webbing end, while making sure that it stays in the elastic loop.



7. Have climber pull blue webbing between/around opposite leg, then secure the buckle. Tighten firmly.



8. Check all buckles to make sure that they are all closed and secure. Make sure that all three webbing ends stay in the elastic loop.

Figure 14. Spectrum Sports Intl Quick-Harness Brochure